



CONTENTS

Introduction	7
Scope of This Manual	7
Typographic Conventions	7
Unpacking and Inspection	7
Safety	7
Terminology and Symbols	7
Installation Considerations	7
Electrical Considerations	8
Important Safety & Usage Instructions	9
Waste Electrical And Electronic Equipment (WEEE) Directive	10
Declaration of Conformity	10
Battery Care	10
Quick-Start Operating Overview	11
Transducer Location	11
Electrical Connections	12
Pipe Preparation and Transducer Mounting	14
Meter Overview	15
General	15
Application Versatility	15
Temperature Ratings for Transducers	15
Data Integrity	15
Product Identification	15
Multilingual Support	15
User Interface	16
DXN Flow Meter Data and Controls Layout	17
Controls	17
Pre-Installation Checklist	20
Charged Battery	20
Tools Not Included with the Flow Meter	20
Prepared Mounting Area for Transducers	20
Transducer Installation	21
Select a Transmission Mode	21
Select a Mounting Location	22
Select a Mounting Configuration	24

Enter the Site, Fluid and Pipe Properties	26
Mount the Transducer	27
DTTSU Small Pipe Transducer Installation	31
Doppler Transducer Installation	32
Display Operation and Configuration.	34
Main Group	36
Meters Page	36
Graph Page	37
Graph Setup Page	38
Table Page	39
Alerts Page.	40
Setup Group	41
Site Page	41
Fluid Page	43
ANSI Pipe Page	45
Pipe Page.	46
Liner Page	51
Transit Page	52
Doppler Page	53
Meter Group	54
Flow Page	54
Totalizer Page	55
Limit Page	56
Filter Page	57
Energy Page	59
Log (Data Logging) Group.	60
Setup Page.	60
Select Data Page	61
I/O (Input / Output) Group.	63
Set Out (Setup Outputs) Page.	63
Scale Out (Scale Outputs) Page.	64
Set In (Setup Input)	65
Test Out (Test Outputs) Page	66
Adv (Advanced) Group	67
Signals Page	67

Transit Page	69
Waveform Page.	70
Doppler Page	71
Monitor Page	72
Cal (Calibration) Group	73
Transit Page	73
Doppler Page	75
Factory Page.	76
System Group.	77
Misc (Miscellaneous) Page	77
Power Page	78
Disk Page.	79
PC Page.	79
Storage Page	80
ENet Page	81
Time Page	84
Update Page.	84
Comm (Communications) Page.	85
Inputs/Outputs.	86
General	86
Total Reset	86
Digital Outputs	87
Analog Outputs	89
Upgrading Software.	91
Quick Boot.	96
Microsoft Software License Terms for Windows XP Embedded and Windows Embedded Standard Runtime.	97
Use Rights	97
Additional Licensing Requirements and/or Use Rights	97
Scope of License	98
Internet-Based Services.	98
Windows Update Agent (also known as Software Update Services).	99
Product Support	99
Backup Copy	99
Proof of License.	99
Transfer to a Third Party	99
Not Fault Tolerant	100

Restricted Use	100
No Warranties for the Software	100
Liability Limitations	100
Export Restrictions.	100
K Factors	101
Description	101
Calculating K Factors	101
Specific Heat Capacity Values for Fluids	103
Specifications.	104
Process Monitoring Inputs/Outputs	104
System	104
Transducers	105
North American Pipe Schedules	105
Fluid Properties	110

INTRODUCTION

Scope of This Manual

This manual is divided into two main sections:

- “Quick-Start Operating Overview” on page 11 is intended to help you get the DXN flow metering system up and running quickly. Refer to the detailed instructions if you require additional information.
- The remaining chapters provide a detailed description of all software settings and hardware installation guidance.

IMPORTANT

Read this manual carefully before attempting any installation or operation. Keep the manual accessible for future reference.

Typographic Conventions

- Items on the software screens that you will be asked to select or choose by clicking a button, highlighting, checking a box or another similar means are in **bold** text and capitalized in the manual.
Example: Press **Delete Site Logs**.
- Names of tabs, pages, options, boxes, columns and fields are *italicized*. In most cases, first letters will be capitalized.
Example: The *Low Flow Limit* is the minimum flow rate at which the meter gives reliable readings.
- Messages and special markings are shown in quotation marks.
Example: “Lock EWF Fail” displays in the text area.

Unpacking and Inspection

Upon opening the shipping container, visually inspect the product and applicable accessories for any physical damage such as scratches, loose or broken parts, or any other sign of damage that may have occurred during shipment.

NOTE: If damage is found, request an inspection by the carrier’s agent within 48 hours of delivery and file a claim with the carrier. A claim for equipment damage in transit is the sole responsibility of the purchaser.

SAFETY

Terminology and Symbols



Indicates a hazardous situation, which, if not avoided, is estimated to be capable of causing death or serious personal injury.



Indicates a hazardous situation, which, if not avoided, could result in severe personal injury or death.



Indicates a hazardous situation, which, if not avoided, is estimated to be capable of causing minor or moderate personal injury or damage to property.

Installation Considerations

The installation of the DXN flow meter system must comply with all applicable federal, state, and local rules, regulations, and codes.



EXPLOSION HAZARD - SUBSTITUTION OF COMPONENTS MAY IMPAIR SUITABILITY FOR CLASS I, DIVISION 2.



RISQUE D’EXPLOSION - LA SUBSTITUTION DE COMPOSANTS PEUT RENDRE CEMATÉRIEL INACCEPTABLE POUR LES EMPLACEMENTS DE CLASSE I, DIVISION 2.

⚠ WARNING

DO NOT CONNECT OR DISCONNECT EITHER POWER OR OUTPUTS UNLESS THE AREA IS KNOWN TO BE NON-HAZARDOUS.

⚠ AVERTISSEMENT

RISQUE D'EXPLOSION. NE PAS DÉBRANCHER TANT QUE LE CIRCUIT EST SOUSTENSION, À MOINS QU'LL NE S'AGISSE D'UN EMPLACEMENT NON DANGEREUX.

IMPORTANT

Not following instructions properly may impair safety of equipment and/or personnel.

IMPORTANT

Must be operated by a Class 2 supply suitable for the location.

Electrical Considerations

Function	Direct Current	Alternating Current	Earth (Ground)	Protective Ground	Chassis Ground
Symbol					

Figure 1: Electrical symbols

The 24V DC power converter and 12V auto-style power cord connect to the 3-pin socket connection located on the back of the enclosure. A fully charged battery provides up to 9 hours of continuous operation before recharging is necessary.

At that point, the meter operates for only a short time more until it automatically turns itself off.

If the flow meter is to be used for extended periods of operation, the 24V DC line power converter or the 12V auto-style converter can remain connected indefinitely.

To charge the internal Lithium-Ion Smart battery, apply power, using the enclosed 24V DC line power converter or auto style power cord, to the flow meter for a period of 4 hours with the unit off. The flow meter has an integral charging circuit that prevents overcharging. The flow meter can be permanently connected to an AC line power without damaging the meter or the battery.

The Lithium-Ion Smart battery is maintenance free, but it still requires a certain amount of attention to prolong its useful life. To obtain the greatest capacity and longevity from the battery, the following practices are recommended:

- When charging or using external power, allow for airflow to the instrument.
- The flow meter's battery management circuitry does not allow the battery to become overcharged.
- The lithium-ion battery is rated for 300 cycles, but may last much longer than that. Cycle counts are shown in the system menu.
- If the meter is stored for prolonged periods of time:
 - Recharge the battery every 6 months and recharge before use.
 - Store at room temperature. Extended exposure above 104° F (40° C) can degrade battery life.
- Do not expose unit to temperatures beyond those specified.
- Battery should only be replaced by authorized personnel.
- In the unlikely event that smoke, abnormal noise or strange odor is present, immediately power off the DXN and disconnect all power sources. Report the problem to your device provider immediately.

Use wiring practices that conform to local codes (National Electric Code® Handbook in the USA). Use only the power converters that have been supplied with the flow meter. The ground terminal, if present on the converter, is mandatory for safe operation.

⚠ CAUTION

ANY OTHER WIRING METHOD MAY BE UNSAFE OR CAUSE IMPROPER OPERATION OF THE INSTRUMENT. IT IS RECOMMENDED NOT TO RUN LINE POWER WITH OTHER SIGNAL WIRES WITHIN THE SAME WIRING TRAY OR CONDUIT.

NOTE: The flow meter requires clean electrical line power. Do not operate the meter on circuits with noisy components (for example, fluorescent lights, relays, compressors, variable frequency drives and like equipment).

The flow meter can be operated from a 10...15V DC source, using the included auto-style power cord, as long as it is capable of supplying at least 40 watts. Observe proper polarity. Note that extended operation on an automotive supply could substantially reduce the automotive battery.

⚠ WARNING

THE INTERNAL BATTERY PACK SHOULD ONLY BE REPLACED BY AN AUTHORIZED BADGER METER SERVICE REPRESENTATIVE. PLEASE CONTACT YOUR PRODUCT AND/OR SERVICE PROVIDER FOR INTERNAL BATTERY REPLACEMENT SERVICE.

Important Safety & Usage Instructions

Read these safety instructions carefully.

- Read all cautions and warnings on the equipment.
- Place this equipment on a reliable surface when installing. Dropping it or letting it fall may cause damage.
- Make sure the correct voltage is connected to the equipment.
- For puggable equipment, the socket outlet should be near the equipment and should be easily accessible.
- If equipment has reached its end of life, please recycle properly.
- Disconnect this equipment from the AC outlet before cleaning it. Use a moist cloth. Do not use liquid or spray detergent for cleaning.
- To fully disengage the power to the unit, disconnect the power from the AC outlet.
- Do not scratch or rub the screen with a hard or sharp object.
- Never use any of the solvents, such as thinner spray-type cleaner, wax, benzene, abrasive cleaner, acid or alkaline solvent, on the display. Harsh chemicals may cause damage to the enclosure and the touch screen sensors.
- Remove dirt with a lightly moistened cloth. Then wipe the enclosure with a soft dry cloth.
- The fins on the enclosure are for air convection and protect the equipment from overheating.
- DO NOT COVER THE OPENINGS.
- Position the power cord so that cannot be stepped on. Do not place anything over the power cord.
- If the meter will not be used for a long time, disconnect it from the power source to avoid damage by transient over-voltage.
- Never pour any liquid into openings. This may cause fire or an electrical shock.
- Never open the equipment. There are no user serviceable parts inside. For safety reasons, the equipment should be opened only by qualified service personnel.
- If one of the following situations arises, get the equipment checked by service personnel:
 - The power cord or plug is damaged.
 - Liquid has penetrated into the equipment.
 - The equipment does not work properly, or you cannot get it to work according to the user's manual.
 - The equipment has been dropped or damaged.
 - The equipment has obvious signs of breakage.

Waste Electrical And Electronic Equipment (WEEE) Directive

In the European Union, this label indicates that this product should not be disposed of with household waste. It should be deposited at an appropriate facility to enable recovery and recycling.

Declaration of Conformity

CE

The CE symbol on your product indicates that it is in compliance with the directives of the Union European (EU).

FCC Class B

This device complies with Part 15 of the FCC Rules.

Certificates of Compliance, Test Reports, and further information is available by contacting Technical Support.

Battery Care

- A portable device should be turned off while charging. This allows the battery to reach the threshold voltage unhindered and reflects the correct saturation current responsible to terminate the charge. A parasitic load confuses the charger.
- Charge at a moderate temperature. Do not charge below freezing.
- Lithium-ion does not need to be fully charged. A partial charge is better.
- Chargers use different methods for ready indication. The light signal may not always indicate a full charge.
- Discontinue using charger and/or battery if the battery gets excessively warm.
- Before prolonged storage, apply some charge to bring the pack to about half charge.

QUICK-START OPERATING OVERVIEW

Follow these instructions to get the system up and running quickly. Refer to the detailed instructions if you require additional information.

NOTE: The following steps require information supplied by the flow meter itself, so power on the flow meter, at least temporarily, to obtain setup information.

Transducer Location

- In general, select a mounting location on the piping system with a minimum of ten pipe diameters (10 × the pipe inside diameter) of straight pipe upstream and five straight diameters downstream. See *Table 1 on page 23* for additional configurations.
- If the application requires DTTR, DTTN, DTTL or DTTT transducers, select a mounting method for the transducers based on pipe size and liquid characteristics. See *Table 2 on page 24*. The three transducer mounting configurations are shown in *Figure 3*. See “*Mount the Transducer*” on page 27 for mounting procedures.
- Avoid installations on downward flowing pipes or pipes that may become partially filled.

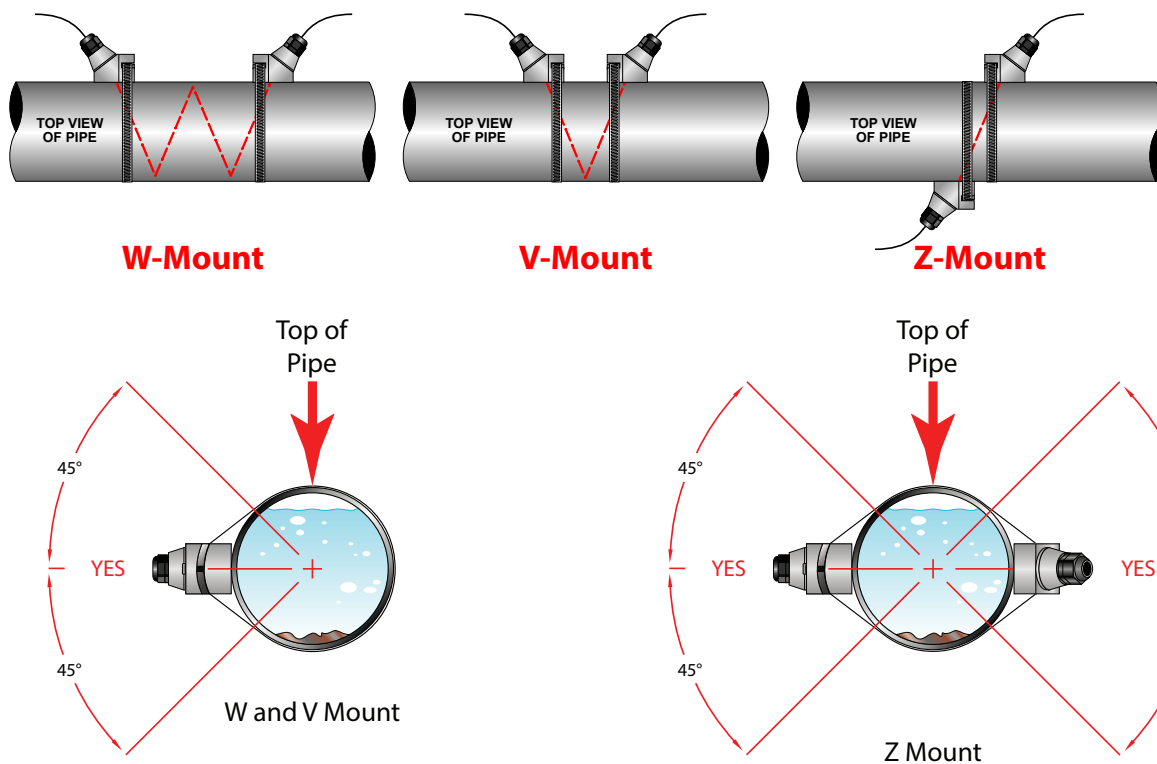

NOTE: Transducers must be mounted 180° from each other to obtain a signal.

Figure 3: Transducer mounting configurations

Electrical Connections

Transducer/Power Connections

1. Route the transducer cables from the transducer mounting location back to the DXN enclosure, avoiding locations near high voltage supply wires.
2. Connect the transit time transducer wires to the appropriate BNC or connect the Doppler transducers to the 4-pin Doppler transducer plug. Both connections are on the end of the DXN enclosure.

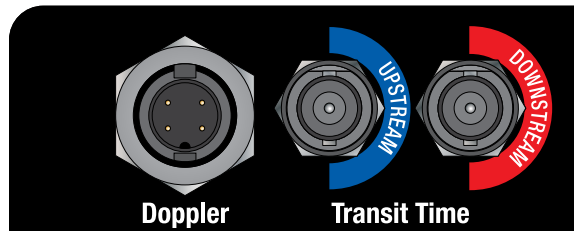

Figure 4: Transducer connections

NOTE: Transit time transducer wires go in opposite directions when DTTR, DTTN, DTTL or DTTT transducers are used (see Table 2 on page 24).

DT94 Doppler transducer wires both go in the direction of flow (see Figure 7 on page 14).

3. Power on the flow meter using the button shown in Figure 5.
4. Upon startup, press the Flow Meter button.

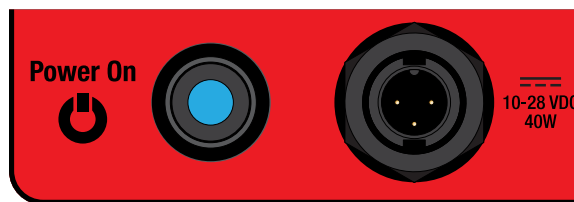

Figure 5: Power switch and charging connections

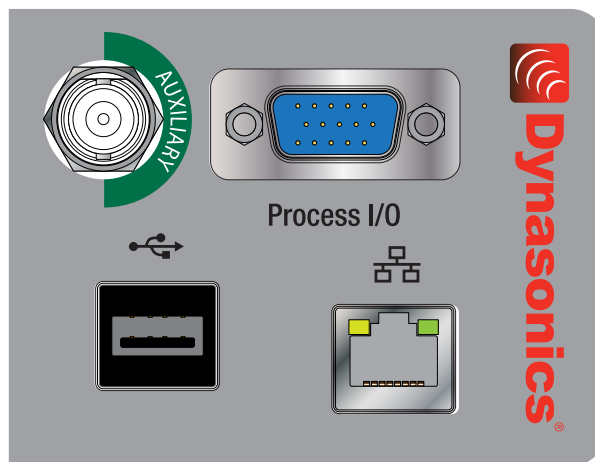

Figure 6: Auxiliary connections

5. Enter the site information into the *Setup > Site* page.
6. Enter the fluid information into the *Setup > Fluid* page.

NOTE: The flow meter contains a programmed fluid table. If a fluid is not in the list, or if known fluid characteristics differ from what is indicated, select **Custom** and edit the fluid characteristics to required values.

7. Enter the piping information.
 - a. For pipes that conform to ANSI specifications, fill in the information with the pull-down menus under *Setup > ANSI Pipe*.
 - Pipe Material
 - ANSI Schedule
 - Nominal Size
 - Liner (not available for all pipe materials)
 - b. For pipes that do not conform to ANSI specifications, or where piping information is unknown, select **Use Manual Entry** in the *Pipe Material* pull-down list under the *Setup > ANSI Pipe* page, then fill in the information under the *Setup > Pipe* page.
 - Pipe Material (If the pull-down list does not contain the correct material, select the closest alternative)
 - Pipe OD
 - Pipe Wall thickness (Use the numeric entry if the value is known, or use the pipe wall thickness gauge feature to determine wall thickness. See *page 48* for details.)

NOTE: Based on *Material* selection, a nominal value for roughness is already provided.

8. Enter the liner information (if applicable) under the *Setup > Liner* page.
9. Enter the transducer information.
 - For transit time flow measurement, enter in the appropriate information under the *Setup > Transit* page. See *Table 2 on page 24* for information on which items to select.
 - Transducer
 - Transducer Mount
10. Record the *Required Spacing* value that was calculated and displayed after all previous steps have been completed. This number will be needed when mounting the transducers. The distances are in inches if the flow meter is configured in English units, or millimeters if configured in metric units.

Pipe Preparation and Transducer Mounting

DTTR, DTTN, DTTL and DTTH Transit Time Transducers

During this procedure, observe the meter's signal quality value, available in *Main > Meters* under *TT Quality*.

1. Make sure *TT Quality* is one of the parameters shown on the *Main > Meters* page. Signal quality should be at least 10%.
2. The pipe surface, where the transducers are to be mounted, must be clean and dry. Remove scale, rust or loose paint to ensure satisfactory acoustic conduction. Wire brushing the rough surfaces of pipes to smooth bare metal may also be useful. Plastic pipes do not require preparation other than cleaning.
3. Apply a single $1/2 \times 1/8$ inch (12×3 mm) bead of acoustic couplant grease to the upstream transducer and secure it to the pipe with a mounting strap.
4. Apply acoustic couplant grease to the downstream transducer and press it onto the pipe using hand pressure at the lineal distance calculated in "*Transducer Location*" on page 11.
5. Space the transducers according to the recommended values found during programming. Secure the transducers with the mounting straps at these locations while making sure to use the alignment marks on the transducers for proper spacing.

DT94 Doppler Transducers

1. In general, select a mounting location on the piping system with a minimum of 10 pipe diameters ($10 \times$ the pipe inside diameter) of straight pipe upstream and 5 straight diameters downstream. See *Table 1 on page 23* for additional configurations.
2. The pipe surface, where the transducers are to be mounted, must be clean and dry. Remove scale, rust or loose paint to ensure satisfactory acoustic conduction. Wire brushing the rough surfaces of pipes to smooth bare metal may also be useful. Plastic pipes do not require preparation other than cleaning.
3. Apply a single $1/2 \times 1/8$ inch (12×3 mm) bead of acoustic couplant grease to both transducers and secure them to the pipe 180 degrees apart using a mounting strap. Make sure the transducer cable is pointing in the downstream direction.

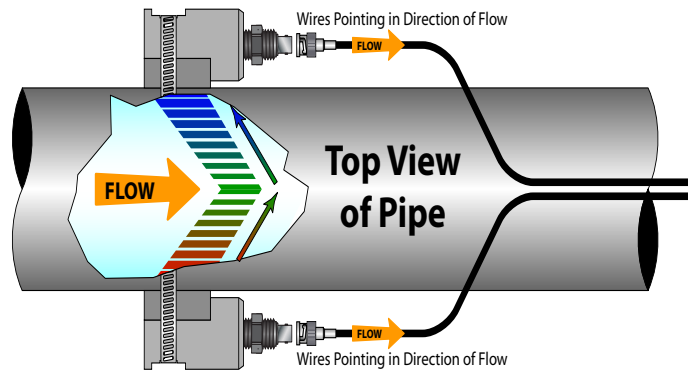

Figure 7: Doppler transducer mounting

METER OVERVIEW

General

The DXN portable ultrasonic flow meter is designed to measure volumetric flow rate within a closed conduit. The transducers are a non-contacting, clamp-on or clamp-around type, which provide the benefits of non-fouling operation and ease of installation.

In *Transit Time* mode, the flow meter uses two transducers that function as both ultrasonic transmitters and receivers. The transducers are clamped on the outside of a closed pipe at a specific distance from each other. The transducers can be mounted in V-Mount, where the sound transverses the pipe two times, W-Mount, where the sound transverses the pipe four times, or in Z-Mount, where the transducers are mounted on opposite sides of the pipe and the sound crosses the pipe once. The selection of mounting method is based on pipe and liquid characteristics, which both have an effect on how much signal is generated. The flow meter operates by alternately transmitting and receiving a frequency modulated burst of sound energy between the two transducers and measuring the time interval that it takes for sound to travel between the two transducers. The difference in the time interval measured is directly related to the velocity of the liquid in the pipe.

Internally, volumetric flow rate is derived from fluid velocity and the cross-sectional area of the pipe inner diameter.

Application Versatility

The flow meter can be successfully applied on a wide range of metering applications because the meter has both transit time and Doppler capabilities. A full range of fluids—from ultrapure to thick slurries—can be measured.

The flow meter can be used on pipe sizes ranging from 0.5...120" (12...3048 mm) while accommodating a wide variety of liquid applications:

ultrapure liquids
chemicals

cooling water
plant effluent

potable water
sewage

river water
sludge

Temperature Ratings for Transducers

Because the transducers are non-contacting and have no moving parts, the flow meter is not affected by system pressure, fouling or wear. Temperature ratings for each transducer are listed below.

Transducer	Temperature Rating
DTTR	-40...250° F (-40...121° C)
DTTN	-40...185° F (-40...85° C)
DTTL	-40...194° F (-40...90° C)
DTTSU	-40...194° F (-40...90° C)
DT94	-40...194° F (-40...90° C)
DTTH	-40...350° F (-40...176° C)

NOTE: When the type of transducer is selected, the flow meter automatically chooses the correct transmission frequency for that transducer set.

Data Integrity

Non-volatile flash memory retains all user-entered configuration values in memory for several years at 77° F (25° C), even if power is lost or turned off.

Product Identification

The serial number and complete model number of the flow meter are located on the bottom surface of the flow meter's body. If you require technical assistance, please provide the customer service department with this information.

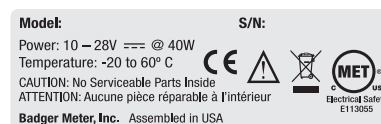

Figure 8: Serial number location

Multilingual Support

To select a language for the user interface display, go to *System > Misc* or use the *Status Bar Control*:

English
Japanese
Russian

Dutch
German
French

Swedish
Portuguese
Italian

Spanish
Norwegian

User Interface

The DXN flow meter has a sophisticated touchscreen user interface to control all functions. The tabbed menu tree provides access to all controls and settings within two layers of menus. Large, easy-to-read touchscreen buttons allow for gloved operation in inclement weather.

CAUTION

DO NOT USE SHARP OBJECTS ON THE TOUCHSCREEN AS DAMAGE WILL OCCUR.

Conventions and Controls

To describe menu navigation, this manual specifies first the *Group Tab* name, and then the *Page*. For example, *Main > Meters*.

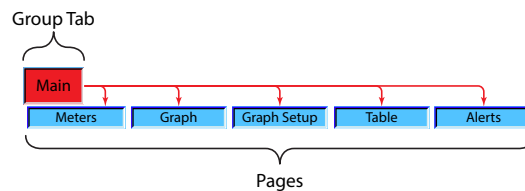

Figure 9: Group > Page convention

Menu Structure

- Group tabs contain page tabs and interface pages.
- Left or right navigation buttons sequentially access the group tabs and page tabs.
- Pressing a group tab or page tab activates that item.
- On some pages, repeatedly pressing an item accesses additional functionality.
- The interface page can contain meters, user entry controls and graphs.

Smart Status Bars

- Status bars contain items that show and control helpful flow meter functions, such as showing flow or controlling data logging.
- The user can navigate status bars sequentially only with the status bar navigation button.
- Certain status items can be double pressed for addition functionality. Oftentimes, they can automatically navigate to a page tab.
- Status bars include Quickview, Power status, Shutdown and Sensor positioning.

DXN FLOW METER DATA AND CONTROLS LAYOUT

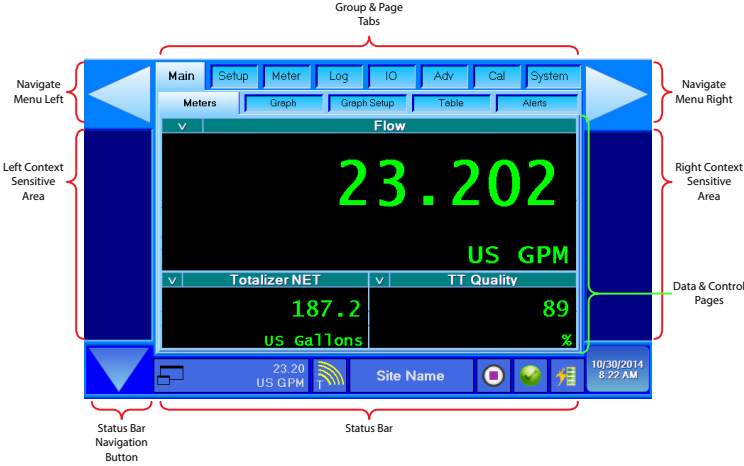

Figure 10: Main user screen layout

Controls

The DXN uses many of the same software controls as common, Windows-based graphical user interfaces. The following describes the controls and how they are used.

Text Boxes

Text boxes (Figure 11) provide space to enter data. For example, when you press the *Create New Site* button, a keyboard pops up, allowing you to enter text and numbers.



Figure 11: Typical text boxes



Figure 12: Alphanumeric keypad

On/Off Check Box

Use the check box to control the state of a function. A checkmark indicates the function is ON. If there is not checkmark, the function is OFF.

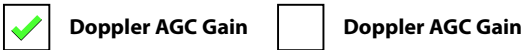

Figure 13: Check box states

When an item is changed, the control temporarily changes to orange while the settings are updated.



Figure 14: Check box transition

Buttons

Button controls work in a similar manner to a push-button switch. Generally, they start or stop a function.

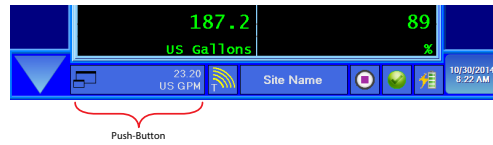

Figure 15: Push-button control

Shutdown Slider

Use the *Shutdown Slider* to turn off the DXN flow meter without having to press and hold the physical *On/Off* button. To use the shutdown slider, press the **Down Arrow** until the red *Shutdown Slider* appears. Press and hold the red button on the left side of the screen. Drag it to the right until it snaps to the right screen stop.

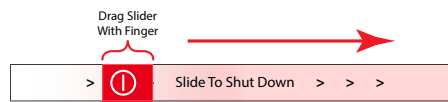

Figure 16: Shutdown slider

Increment/Decrement Control

To enter numeric data:

- Use the **+** (*Increment*) and **-** (*Decrement*) buttons to select numeric data, or
- Double-tap the numerical value area and use the pop-up keypad to enter the numbers.



Figure 17: Increment/decrement control

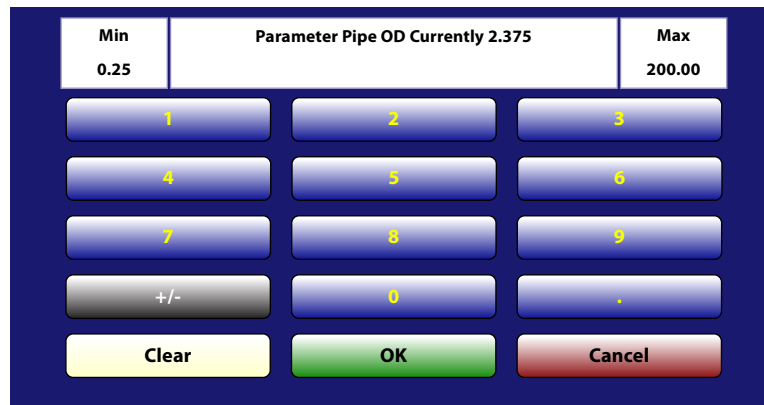

Figure 18: Numeric input control

Min, Max and the selected parameter all display on the top line of the numeric keypad.

- Press **Clear** to start over.
- Press **Cancel** to close without changes.
- Press **OK** to store the new value and close the keypad.

Combo Box

An arrow to the left of a box indicates the box contains a list of options.

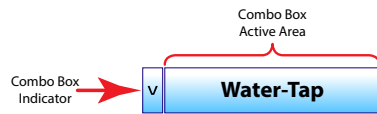

Figure 19: Retracted combo box

Press the box's active area to show the choices for that parameter.

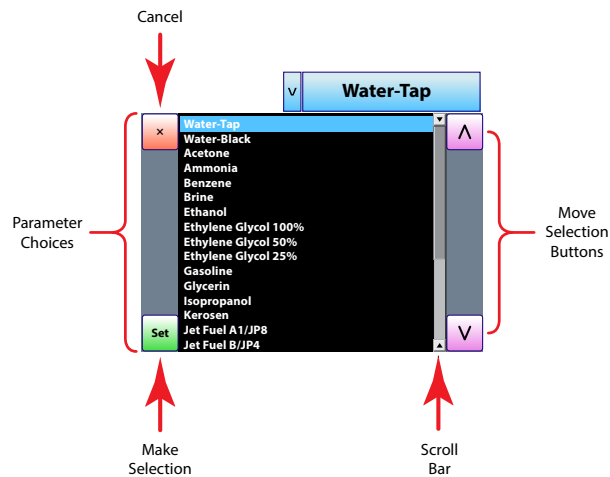





Figure 20: Combo box with large scroll bars

The  (Up) and  (Down) arrow buttons moves the blue highlighted area up or down, depending on the original position of the highlight. Use the  (Set) button to lock in the highlighted selection or use the  (Cancel) button to exit the combo box without making any changes.

If the drop-down list of parameters is too large to be contained in one combo box length, you can move the large scroll bar up or down to display the remaining parameters.

A small scroll bar is also used when parameter entries are too numerous for a single screen page. The scroll bars may appear either horizontally or vertically.



Figure 21: Small scroll bar

PRE-INSTALLATION CHECKLIST

Charged Battery

Charge the battery for four hours with the flow meter turned OFF.

Tools Not Included with the Flow Meter

- A 5/16 in. nut driver or a flat-head screwdriver
- Permanent marker or other utensil that will make a visible mark on the pipe
- Tape for larger pipe configuration, Z-mode
- Scissors for larger pipe configuration, Z-mode
- Rag or paper towels

Prepared Mounting Area for Transducers

- The pipe surface where the transducers are to be mounted must be clean and dry.
- Remove scale, rust or loose paint to provide satisfactory acoustic conduction.
- Wire brush the rough surfaces of pipes to smooth bare metal.
- Plastic pipes do not require preparation, other than cleaning.

TRANSDUCER INSTALLATION

The transducers for the DXN flow meter contain piezoelectric crystals that transmit and receive ultrasonic signals through the walls of liquid piping systems.

DTTR, DTTN, DTTL, DTTH and DT94 transducers are relatively simple and straightforward to install, but spacing and alignment of the transducers is critical to the system's accuracy and performance. **CAREFULLY PERFORM THESE INSTRUCTIONS.**

DTTSU small pipe transducers have integrated transmitter and receiver elements. A spacing slider is provided to adjust the required spacing, based on pipe size and mounting method.

Mounting the DTTR, DTTN, DTTL, DTTH and DT94 clamp-on ultrasonic transit time transducers takes four steps:

1. Select the optimum transmission mode and mounting location on a piping system.
2. Select a mounting configuration.
3. Enter the site information, then the fluid pipe properties for the specific site.
4. Prepare the pipe and mount the transducers.

Select a Transmission Mode

The first decision to be made is what mode of ultrasonic transmission to use.

- Use *Transit Time* mode with fluids that have little to no particulates or entrained air.
- Use *Doppler* mode with fluids that contain significant levels of particulates and aerated fluids.
- Use *Hybrid* mode to automatically switch between *Transit Time* and *Doppler* modes.

If the fluid type is unknown, start with *Transit Time* mode, which is more forgiving of having **some** particulate or air than *Doppler* mode is of **not having enough** particulate or entrained air.

If the fluid type is an unknown, you can mount both *Transit Time* and *Doppler* transducers on the same pipe and let the flow meter decide which set of transducers to use. The flow meter can operate as a dedicated *Transit Time* meter, a dedicated *Doppler* meter or it can automatically switch between *Transit Time* and *Doppler* modes using the *Hybrid* mode.

Signal Quality

When the flow meter is in *Hybrid* mode, switching between *Transit Time* and *Doppler* modes is controlled by the signal quality. For any mode setting elected from the Meter > Flow page, the signal quality must be at least 10% to obtain any readings.

Above a signal quality of 10%, but below 40%, the flow meter uses the mode that develops the highest signal quality. If, for example, the *Doppler* signal quality is 38% and *Transit Time* signal quality is 33%, *Doppler* is automatically selected. Above 40%, the flow meter uses *Transit Time*.

Select a Mounting Location

At this point, consider the transducer mounting location. A guiding principle is to mount the transducers on a section of pipe that has at least 10 pipe diameters upstream of the transducers and 5 pipe diameters downstream. See *Table 1 on page 23* for additional pipe length considerations.

For example, if a 3 inch pipe is being measured, the minimum upstream pipe in front of the transducers should be 30 inches and the minimum downstream pipe behind the transducers should be at least 15 inches.

Pipe runs shorter than the minimums may sometimes be used with reduced accuracy. There is no way to determine how much accuracy is sacrificed without doing in-field testing. For installations where the 10/5 pipe diameters rule cannot be followed, divide the total length of available straight pipe into thirds and mount the transducers with 2/3 of the pipe upstream and 1/3 of the pipe downstream.

A full pipe is absolutely essential for making accurate flow measurements in either *Transit Time* and *Doppler* mode. The flow meter cannot determine if the pipe is full or not. If the pipe is partially full, the meter will over report the amount of flow by the percentage of the pipe that is not filled with liquid.

An optimum transducer mounting location is defined as:

- A piping system that is completely full of liquid when measurements are being taken. The pipe may become empty during a process cycle, which results in a "Low Signal Strength" error while the pipe is empty. This error code clears automatically when the pipe refills with liquid. Do not mount the transducers in an area where the pipe may become partially filled. Partially filled pipes cause erroneous and unpredictable operation of the meter.
- A piping system that contains lengths of straight pipe such as those described in *Table 1 on page 23*. The optimum straight pipe diameter recommendations apply to pipes in both horizontal and vertical orientation. The straight runs in *Table 1* apply to liquid velocities that are nominally 7 fps (2.2 mps). As liquid velocity increases above this nominal rate, the requirement for straight pipe increases proportionally.
- Mount the transducers in an area where they will not be inadvertently bumped or disturbed.
- Avoid installations on downward flowing pipes unless adequate downstream head pressure is present to overcome partial filling of or cavitation in the pipe.

Piping Configuration and Transducer Positioning	Upstream Pipe Diameters	Downstream Pipe Diameters
	*	**
	14	5
	10	5
	10	5
	10	5
	24	5

Table 1: Piping configuration and transducer positioning

The DXN flow metering system provides repeatable measurements on piping systems that do *not* meet these pipe diameter requirements, but the accuracy of the readings may be influenced.

Select a Mounting Configuration

The flow meter can be used with these transducer types: DTTR, DTTN, DTTL, DTTH, DTTSU and DT94. Meters that use transducer sets consist of two separate sensors that function as both ultrasonic transmitters and receivers. The transducers are clamped on the outside of a closed pipe at a specific distance from each other.

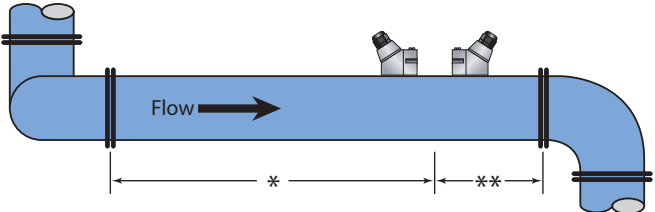
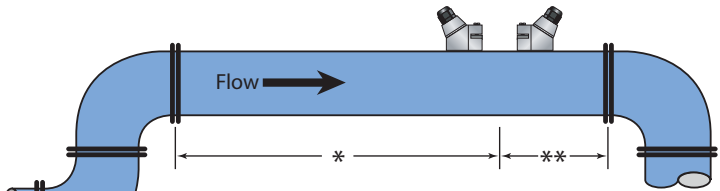
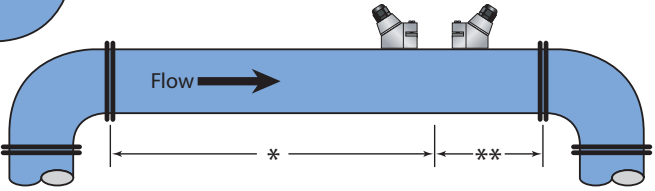
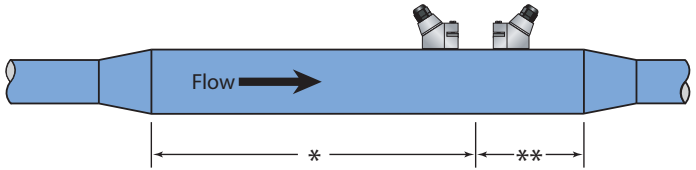
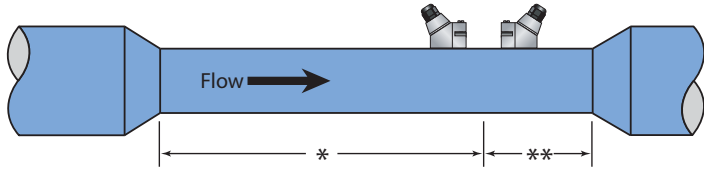
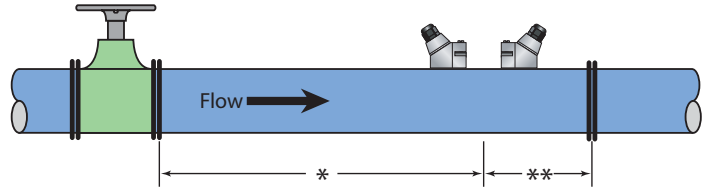
The transducers can be mounted in:

- **W-Mount** where the sound traverses the pipe four times. This mounting method produces the best relative travel time values but the weakest signal strength.
- **V-Mount** where the sound traverses the pipe twice. **V-Mount** is a compromise between travel time and signal strength.
- **Z-Mount** where the transducers are mounted on opposite sides of the pipe and the sound crosses the pipe once. **Z-Mount** yields the best signal strength but the smallest relative travel time.

Transducer Mount Mode	Transducer	Pipe Material	Pipe Size
W-Mount	DTTR/DTTN/DTTH	Plastic (all types)	2...4 in. (50...100 mm)
		Carbon Steel	
		Stainless Steel	
		Copper	
		Ductile Iron	
	DTTL	Cast Iron	Not recommended
		Plastic (all types)	8...16 in. (203...406 mm)
		Carbon Steel	
		Stainless Steel	
		Copper	
Ductile Iron			
V-Mount	DTTR/DTTN/DTTH	Cast Iron	Not recommended
		Plastic (all types)	4...12 in. (203...406 mm)
		Carbon Steel	
		Stainless Steel	
		Copper	
	Ductile Iron		
	DTTL	Cast Iron	4...30 in. (100...750 mm)
		Plastic (all types)	2...12 in. (50...300 mm)
		Carbon Steel	16...48 in. (406...1220 mm)
		Stainless Steel	16...36 in. (406...915 mm)
Copper		16...48 in. (406...1220 mm)	
Z-Mount	DTTR/DTTN/DTTH	Ductile Iron	16...30 in. (406...750 mm)
		Cast Iron	> 30 in. (> 750 mm)
		Plastic (all types)	> 12 in. (> 300 mm)
		Carbon Steel	> 30 in. (> 750 mm)
		Stainless Steel	> 12 in. (> 300 mm)
	DTTL	Copper	> 30 in. (> 750 mm)
		Ductile Iron	> 48 in. (> 1220 mm)
		Cast Iron	> 36 in. (> 915 mm)
		Plastic (all types)	> 48 in. (> 1220 mm)
		Carbon Steel	> 30 in. (> 750 mm)
DTTL	Stainless Steel	> 36 in. (> 915 mm)	
	Copper	> 48 in. (> 1220 mm)	
	Ductile Iron	> 30 in. (> 750 mm)	
	Cast Iron	> 30 in. (> 750 mm)	
	Plastic (all types)	> 48 in. (> 1220 mm)	

Table 2: Transducer mounting modes for DTTR, DTTN, DTTL and DTTH

Transducer Mount Mode	Transducer	Pipe Material	Pipe Size
W-Mount	DTTSU	Plastic (all types)	0.5...0.75" (12.7...19 mm)
		Carbon Steel	
		Stainless Steel	
		Copper	
V-Mount		Galvanized	Not recommended
		Plastic (all types)	0.75...2.4" (19...61 mm)
		Carbon Steel	
		Stainless Steel	
Copper			
		Galvanized	0.5...2.4" (12.7...61 mm)

Table 3: Transducer mounting modes for DTTSU

DTTL transducers may also be advantageous on pipes between 4...24 inches if there are less quantifiable complicating aspects, such as sludge, tuberculation, scale, rubber liners, plastic liners, thick mortar, gas bubbles, suspended solids, emulsions, or pipes that are partially buried where a V-mount is required or desired.

The DTTR, DTTN, DTTT and DTTL transducers must be properly oriented and spaced on the pipe to provide optimum reliability and performance. On horizontal pipes, when Z-Mount is required, the transducers should be mounted 180 radial degrees from one another and at least 45 degrees from the top-dead-center and bottom-dead-center of the pipe. See Figure 30 on page 29. Also see "Z-Mount Installation" on page 28. On vertical pipes the orientation is not critical.

The best accuracy is achieved when transducer spacing is exactly what the flow meter calculates, so the calculated spacing should be used if signal quality is satisfactory. If the pipe is not round, the wall thickness not correct or the actual liquid being measured has a different sound speed than the liquid programmed into the transmitter, the spacing can vary from the calculated value. If that is the case, the transducers should be placed at the highest signal level observed by moving the transducers slowly around the mount area.

NOTE: Transducer spacing is calculated on ideal pipe. Ideal pipe is almost never found so the transducer spacing distances may need to be altered. An effective way to maximize signal quality is to configure the display to show signal quality, fix one transducer on the pipe and then starting at the calculated spacing, move the remaining transducer small distances forward and back to find the maximum signal quality point.

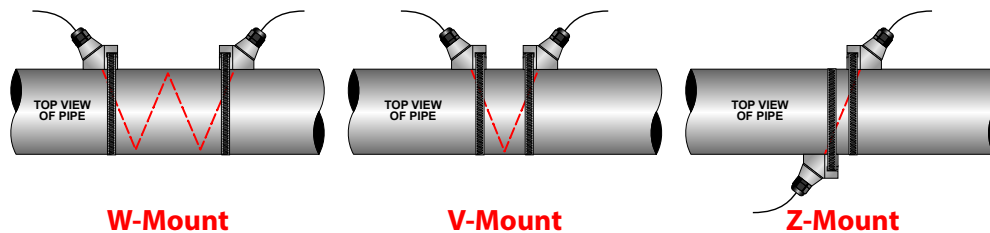

Figure 22: Transducer mounting modes for DTTR, DTTN, DTTL and DTTT

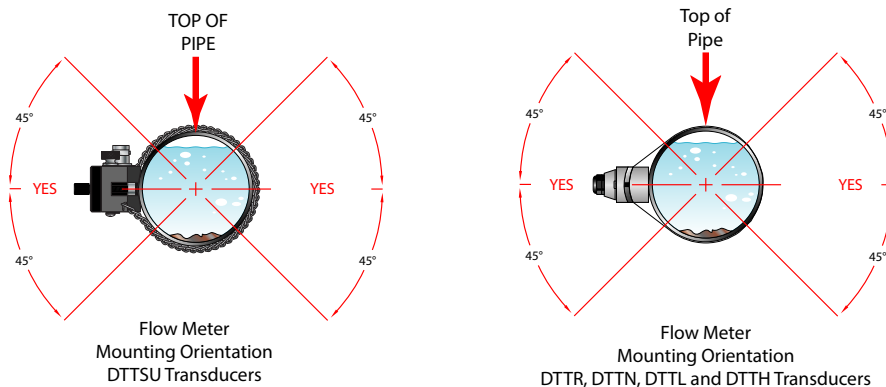

Figure 23: Transducer orientation for horizontal pipes

Enter the Site, Fluid and Pipe Properties

The DXN has the ability to store over 300 sites. Each site contains fluid and piping characteristics as well as other settings that are configured during meter commissioning. Sites are recallable from a pull-down menu each time the specific site is visited. This makes period measurements of the particular site less time consuming. For further detail on sites, see “Site Page” on page 41.

The DXN flow metering system calculates proper transducer spacing based on the piping and mounting method information you enter into the flow meter via the touchscreen display.

The most accuracy is achieved when the transducer spacing is exactly what the flow meter calculates, so use the calculated spacing if the signal strength is satisfactory. If the pipe is not round, the wall thickness not correct or the actual liquid being measured has a different sound speed than the liquid programmed into the flow meter, the spacing can vary from the calculated value. In that case, place the transducers at the highest signal level observed when moving the transducers slowly around the mount area.

NOTE: Transducer spacing is calculated on “ideal” pipe. Ideal pipe almost never exists, so you may need to alter the transducer spacing. An effective way to maximize signal strength is to configure the display to show signal strength, fix one transducer on the pipe and then—starting at the calculated spacing—move the remaining transducer small distances forward and back to find the maximum signal strength point.

IMPORTANT

Enter all of the data on this list before mounting the transducers.

1. Enter the pipe information.
 - a. For pipes conforming to ANSI specifications, fill in the information with the pull-down menus under *Setup > ANSI Pipe*.
 - Pipe Material
 - ANSI Schedule
 - Nominal Size
 - Liner (For Ductile Iron)
 - b. For pipes that do not conform to ANSI specifications, or where piping information is unknown, select **Use Manual Entry** in the *Pipe Material* pull-down under the *Setup > ANSI Pipe* page, then fill in the information under the *Setup > Pipe* page.
 - Pipe Material (If the pull-down list does not contain the correct material, select the closest alternative.)
 - Pipe OD
 - Pipe Wall thickness (Use the numeric entry if the value is known, or use the pipe wall thickness gauge feature to determine wall thickness. See page 48 for details.)
- NOTE:** Based on *Material* selection, a nominal value for roughness is already provided.
2. Enter the liner information (if applicable) under the *Setup > Liner* page.
3. Enter the transducer information
4. For transit time flow measurement, enter in the appropriate information under the *Setup > Transit* page. See Table 2 on page 24 for information on which items to select.
 - Transducer
 - Transducer Mount
5. Record the *Required Spacing* value that was calculated and displayed after all previous steps have been completed. This number will be needed when mounting the transducers. The distances are in inches if the flow meter is configured in English units, or millimeters if configured in metric units.

Mount the Transducer

After selecting an optimal mounting location and determining the proper transducer spacing, mount the transducers onto the pipe.

1. Clean the surface of the pipe. If the pipe has external corrosion or dirt, wire brush, sand or grind the mounting location until it is smooth and clean. Paint and other coatings, if not flaked or bubbled, need not be removed. Plastic pipes typically do not require surface preparation other than soap and water cleaning.
2. Orient and space the transducers on the pipe to provide optimum reliability and performance. On horizontal pipes, when Z-Mount is required, mount the transducers 180 radial degrees from one another and at least 45 degrees from the top-dead-center and bottom-dead-center of the pipe. See *Figure 23 on page 25*. Also see “Z-Mount Installation” on *page 28*. On vertical pipes, the orientation is not critical.

The spacing between the transducers is measured between the two spacing marks on the sides of the transducers. These marks are approximately 0.75 inches (19 mm) back from the nose of the DTTR, DTTN and DTTH transducers, and 1.2 inches (30 mm) back from the nose of the DTTL transducers. See *Figure 25*.

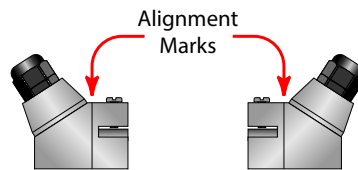

Figure 25: Transducer alignment marks

V-Mount and W-Mount Installation

Apply the Couplant

For DTTR, DTTN, DTTL and DTTH transducers, place a single bead of couplant, approximately 1/2 inch (12 mm) thick, on the flat face of the transducer. See *Figure 26*. Generally, a silicone-based grease is used as an acoustic couplant, but any good quality grease-like substance that is rated to not flow at the operating temperature of the pipe is acceptable. For pipe surface temperature over 130° F (55° C), use Sonotemp® (P.N. D002-2011-010).

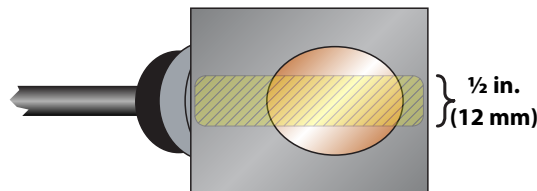

Figure 26: Application of couplant

Position and Secure the Transducer

1. Place the upstream transducer in position and secure with a mounting strap. Place the straps in the arched groove on the end of the transducer. Use the screw provided to help hold the transducer onto the strap. Verify that the transducer is true to the pipe and adjust as necessary. Tighten the transducer strap securely.
2. Using the alignment marks, place the downstream transducer on the pipe at the calculated transducer spacing. See *Figure 27 on page 28*. Apply firm hand pressure. If signal strength is greater than 10%, secure the transducer at this location. If the signal strength is not greater than 10%, using firm hand pressure, slowly move the transducer both towards and away from the upstream transducer while observing signal strength. Signal strength can be displayed on the flow meter's display. Clamp the transducer at the position where the highest signal strength is observed. The factory default signal strength setting is 10%. However, there are many application-specific conditions that may prevent the signal strength from attaining this level. Signal levels less than 10% are not acceptable for reliable readings.

NOTE: Signal strength readings update only every few seconds. Move the transducer 1/8 inch, then wait to see if the signal is increasing or decreasing. Repeat until the highest level is achieved.

3. If, after adjusting the transducers, the signal strength does not rise to 10%, use an alternate transducer mounting configuration. If the mounting configuration was **W**-Mount, re-configure the flow meter for **V**-Mount, move the downstream transducer to the new spacing distance and repeat the procedure “Enter the Site, Fluid and Pipe Properties” on *page 26*.

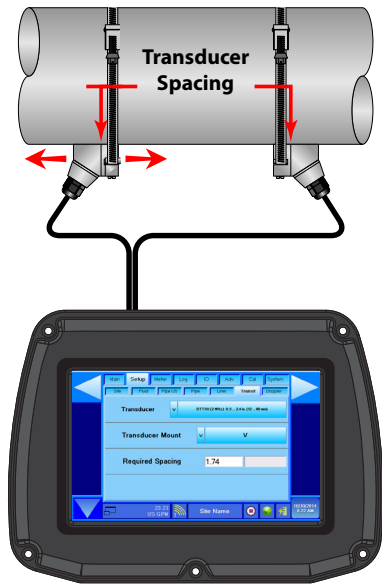

Figure 27: Transducer positioning

NOTE: Use the DTTL transducer on pipes 24 inches and larger and not on pipes smaller than 4 inches. You can consider using the DTTL transducers on pipes smaller than 24 inches if there are less quantifiable aspects—such as sludge, tuberculation, scale, rubber liners, plastic liners, thick mortar liners, gas bubbles, suspended solids, emulsions—and smaller pipes that are perhaps partially buried where a *V-Mount* is required or desired.

Z-Mount Installation

Installation on larger pipes requires careful measurements of the linear and radial placement of the DTTR, DTTN, DTTL and DTTT transducers. Failure to properly orient and place the transducers on the pipe may lead to weak signal strength and/or inaccurate readings. This section details a method for properly locating the transducers on larger pipes. This method requires a roll of paper such as freezer paper or wrapping paper, masking tape and a marking device.

1. Wrap the paper around the pipe in the manner shown in *Figure 28*. Align the paper ends to within 1/4 inch (6 mm).
2. Mark the intersection of the two ends of the paper to indicate the circumference. Remove the template and spread it out on a flat surface. Fold the template in half, bisecting the circumference. See *Figure 29*.
3. Crease the paper at the fold line. Mark the crease. Place a mark on the pipe where one of the transducers will be located. See *Figure 23* for acceptable radial orientations. Wrap the template back around the pipe, placing the beginning of the paper and one corner in the location of the mark. Move to the other side of the pipe and mark the pipe at the ends of the crease. Measure from the end of the crease (directly across the pipe from the first transducer location) the dimension derived in “*Select a Mounting Configuration*” on page 24. Mark this location on the pipe.
4. The two marks on the pipe are now properly aligned and measured. If access to the bottom of the pipe prohibits the wrapping of the paper around the circumference, cut a piece of paper 1/2 the circumference of the pipe and lay it over the top of the pipe. The equation for the length of 1/2 the circumference is: $1/2 \text{ Circumference} = \text{Pipe O.D.} \times 1.57$

The transducer spacing is the required spacing value that was recorded during setup. Mark opposite corners of the paper on the pipe. Apply transducers to these two marks.

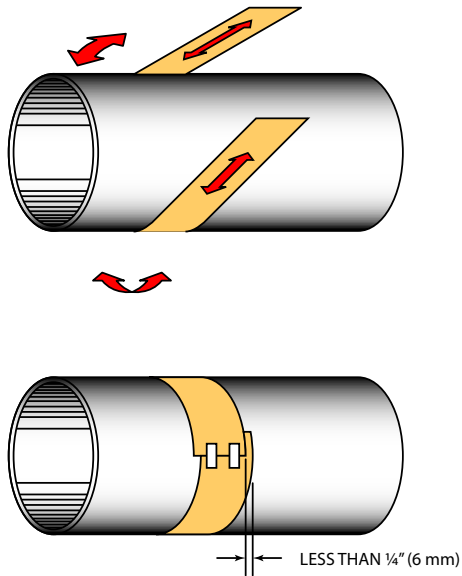

Figure 28: Paper template alignment

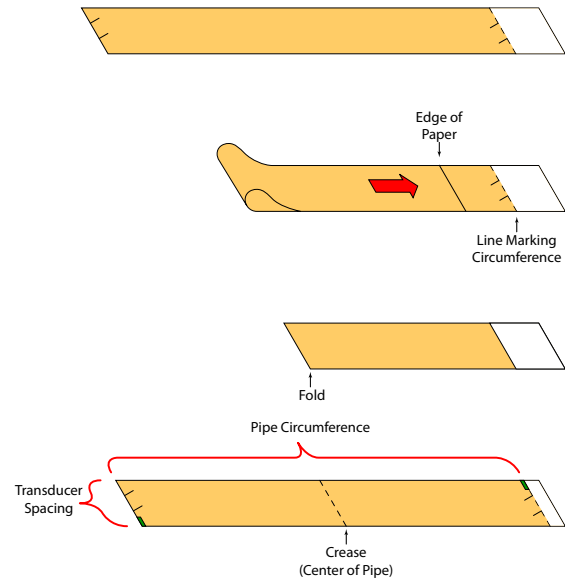

Figure 29: Bisecting the pipe circumference

5. For DTTR, DTTN, D TTL and D TTH transducers, place a single bead of couplant, approximately 1/2 inch (12 mm) thick, on the flat face of the transducer. See Figure 26. Generally, a silicone-based grease is used as an acoustic couplant, but any good quality grease-like substance that is rated to not flow at the operating temperature of the pipe is acceptable.
6. Place the upstream transducer in position and secure with a stainless steel strap or other fastening device. Straps should be placed in the arched groove on the end of the transducer. A screw is provided to help hold the transducer onto the strap. Verify that the transducer is true to the pipe, adjust as necessary. Tighten transducer strap securely. Larger pipes may require more than one strap to reach the circumference of the pipe.

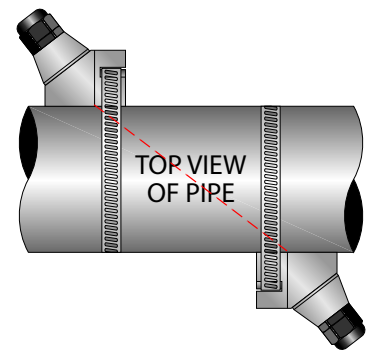

Figure 30: Z-Mount transducer placement

7. Place the downstream transducer on the pipe at the calculated transducer spacing. See Figure 30. Using firm hand pressure, slowly move the transducer both towards and away from the upstream transducer while observing signal strength. Clamp the transducer at the position where the highest signal strength is observed. A signal strength percentage between 10...98 is acceptable.

The factory default signal strength setting is 10%. However, there are many application-specific conditions that may prevent the signal strength from attaining this level. A minimum signal strength of 5% is acceptable as long as this signal level is maintained under all flow conditions.

On certain pipes, a slight twist to the transducer may cause signal strength to rise to acceptable levels. Certain pipe and liquid characteristics may cause signal strength to rise to greater than 98. The problem with operating this flow meter with very high signal strength is that the signals may saturate the input amplifiers and cause erratic readings. Strategies for lowering signal strength would be changing the transducer mounting method to the next longest transmission path. For example, if there is excessive signal strength and the transducers are mounted in a **Z**-Mount, try changing to **V**-Mount or **W**-Mount. Finally, you can also move one transducer slightly off-line with the other transducer to lower signal strength.

8. Secure the transducer with a stainless steel strap or other fastener.

Mounting Rail System Installation for DTTR

For remote flow DTTR transducers with outside diameters between 2...10 inches (50...250 mm), the rail mounting kit aids in installation and positioning of the transducers. Transducers slide on the rails, which have measurement markings that are viewable through the sight opening.

1. Install the single mounting rail on the side of the pipe with the stainless steel bands provided. Do not mount it on the top or bottom of the pipe. On vertical pipe, orientation is not critical. Check that the track is parallel to the pipe and that all four mounting feet are touching the pipe.
2. Slide the two transducer clamp brackets toward the center mark on the mounting rail.
3. Place a single bead of couplant, approximately 1/2 inch (12 mm) thick, on the flat face of the transducer.
See *Figure 26 on page 27*.
4. Place the first transducer in between the mounting rails near the zero point on the scale. Slide the clamp over the transducer. Adjust the clamp and transducer so the notch in the clamp aligns with the zero on the scale. See *Figure 32*.
5. Secure with the thumb screw. Check that the screw rests in the counter bore on the top of the transducer. (Excessive pressure is not required. Apply just enough pressure so that the couplant fills the gap between the pipe and transducer.)
6. Place the second transducer in between the mounting rails near the dimension derived in the transducer spacing section, while using the alignment marks. Read the dimension on the mounting rail scale. Slide the transducer clamp over the transducer and secure with the thumb screw.

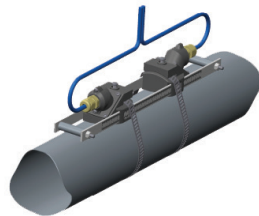

Figure 31: Mounting rail system for DTTR

Mounting Track Installation for DTTN/DTTH

A convenient transducer mounting track can be used for pipes that have outside diameters between 2...10 inches (50...250 mm) or 2...16 inches (50...406 mm) and for DTTN/DTTH transducers. If the pipe is outside of that range, mount the transducers separately.

1. Install the single mounting rail on the side of the pipe with the stainless steel bands provided. Do not mount it on the top or bottom of the pipe. On vertical pipe, orientation is not critical. Check that the track is parallel to the pipe and that all four mounting feet are touching the pipe.
2. Slide the two transducer clamp brackets toward the center mark on the mounting rail.
3. Place a single bead of couplant, approximately 1/2 inch (12 mm) thick, on the flat face of the transducer.
See *Figure 26 on page 27*.
4. Place the first transducer in between the mounting rails near the zero point on the scale. Slide the clamp over the transducer. Adjust the clamp and transducer so the notch in the clamp aligns with the zero on the scale. See *Figure 32*.
5. Secure with the thumb screw. Check that the screw rests in the counter bore on the top of the transducer. (Excessive pressure is not required. Apply just enough pressure so that the couplant fills the gap between the pipe and transducer.)
6. Place the second transducer in between the mounting rails near the dimension derived in the transducer spacing section.
7. Read the dimension on the mounting rail scale. Slide the transducer clamp over the transducer and secure with the thumb screw.

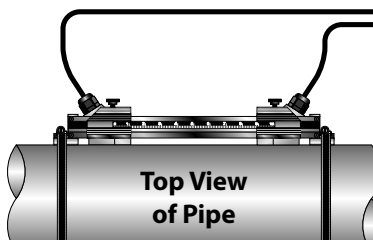

Figure 32: Mounting track installation

DTTSU Small Pipe Transducer Installation

Mount DTTSU transducers with the cable exiting within ± 45 degrees of the side of a horizontal pipe. On vertical pipes the orientation does not apply.

The DTTSU small pipe transducers are adjustable for pipe sizes between 1/2...2 in. (12...50 mm). Do not attempt to mount a DTTSU transducer onto a pipe that is either too large or too small for the transducer.

1. Determine the transducer spacing required using the flow meter and the scale on the side of the DTTSU transducers, set the spacing. See *Figure 34*.
2. On horizontal pipes, mount the transducer in an orientation such that the cable exits at ± 45 degrees from the side of the pipe. Do not mount with the cable exiting on either the top or bottom of the pipe. On vertical pipes the orientation does not matter.

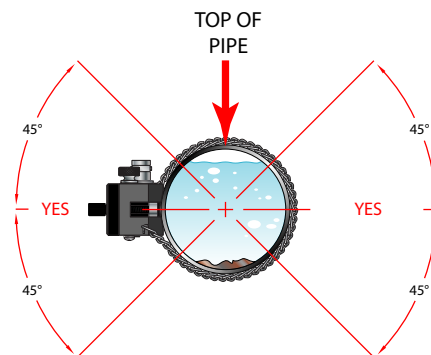

Figure 33: DTTSU positioning

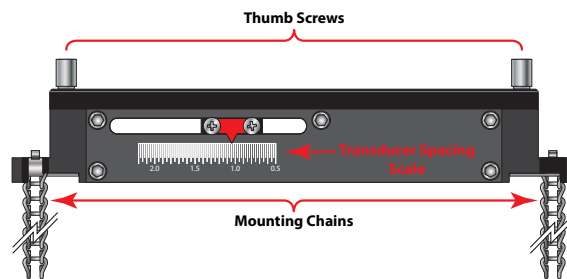

Figure 34: Transducer spacing scale for DTTSU transducers

3. Wrap the mounting chains around the pipe and secure the chains to their respective mounting cleats. See *Figure 35*.



Figure 35: DTTSU transducers mounted

NOTE: The chains do not need to be taut at this point. Any slack in the chains is removed when the thumb screws are adjusted.

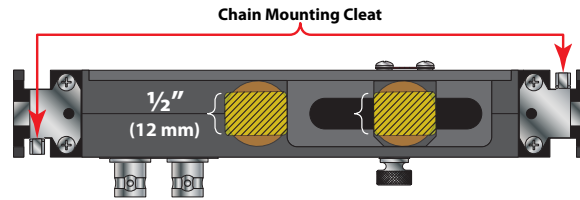

Figure 36: Application of acoustic couplant for DTTSU transducers

4. Finger tighten the thumb screws so that the acoustic coupling grease begins to flow out from the under the transducer. Do not over tighten.
5. If signal quality is less than 10%, remount the transducer at another location on the piping system.

Doppler Transducer Installation

For Doppler installation, the only pipe information needed is the Pipe Inside Diameter.

Sonic Reflectors for Doppler Mode

Flow meters based on Doppler shift principals operate by transmitting an ultrasonic sound from its transmitting transducer through the pipe wall into the flowing liquid. The sound reflects off sonic reflectors suspended within the liquid and recorded by the receiving transducer. If the sonic reflectors are moving within the sound transmission path, sound waves are reflected at a frequency shifted (Doppler frequency) from the transmitted frequency. The shift in frequency is directly related to the speed of the moving particle or bubble. This shift in frequency is interpreted by the instrument and converted to various user defined measuring units.

The four criteria for a good Doppler reflectors are :

1. The scattering material must have a sonic impedance (sound speed difference) different from the fluid. The minimum difference must be at least 10%.
2. There must be some particles large enough to cause longitudinal reflection—particles larger than 35 micron (435 mesh).
3. For a given pipe size, the longitudinal reflection must have sufficient energy to overcome the Rayleigh (energy wasting) scattering caused by smaller particles.
4. The reflecting material must travel at the same velocity as the fluid for good accuracy.

Installation Method

Mount Doppler transducers on the pipe 180 degrees apart and facing each other, with the cables on the downstream side of the transducers. If the pipe is horizontal, the preferred mounting orientation is 3 and 9 o'clock, with 12 o'clock being the top of the pipe. See *Figure 37*. Orientation on vertical pipes does not matter.

NOTE: Doppler transducers may be mounted on the same pipe as transit time transducers without encountering acoustic cross-talk.

1. Large pipe installations use stainless steel straps to secure the transducers to the outside of the pipe. The DXN system is shipped with four 36 in. (900 mm) straps, which are suitable for pipes up to 39 in. (1000 mm) diameter. Select the proper number of transducer straps to allow a complete strap to go around the circumference of the pipe. See *Table 4* on page 33.
2. Wrap the strap around the pipe in the area where the transducers are to be mounted. Leave the strap loose enough to allow the transducers to be placed underneath. If multiple straps are being used, it can be beneficial to wrap electrical tape around all but one strap connection to secure the strap worm screws in place.
3. Spread an even layer of coupling compound, approximately 1/8 in. (3 mm) thick by 1/2 in. (12 mm) wide, to the bottom flat face of the two transducers.
4. Place each transducer under the strap with the flat face—amber plastic window—positioned towards the pipe. The notch on the back of the transducer provides a mounting surface for the strap. The transducer cables must be facing in the same direction and in the downstream direction for proper operation.

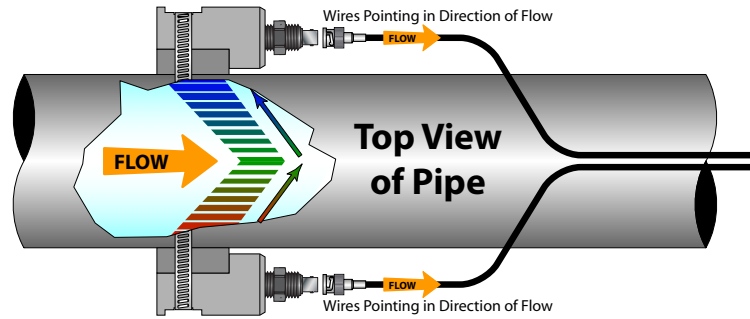

Figure 37: Doppler transducer placement

NOTE: Large pipes may require two people for this procedure.

5. Tighten the strap enough to hold the transducers in place, but not so tight that all of the couplant squeezes out of the gap between the transducer face and pipe. Align the transducers squarely on the pipe and 180 degrees apart.
6. Route the transducer cables back to the flow meter location, avoiding high voltage cable trays and conduits.

NOTE: Where a high amount of particulates are expected mounting the transducers side-by-side may allow enough sound reflection for the Doppler function to work.

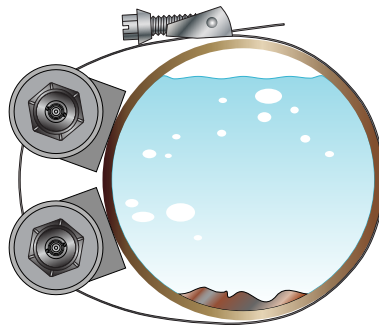

Figure 38: Side-by-side placement

NOTE: Low particulate content may sometimes be overcome by mounting the Doppler transducers downstream of a pipe elbow. A better solution to a low particulate fluid would be switching over to transit time measurements.

Mounting Straps

The most economical way to affix DTTR, DTTN, DTTH, DTTL and DT94 transducers to a pipe is by using adjustable mounting straps. Individual straps in both 36 in. (900 mm) and 72 in. (1830 mm) are available from Badger Meter. See *Table 4* for required number of straps. The straps can be connected together to make a continuous length. Small pipe transducer installations do not use straps, but use an integral clamping mechanism built into the transducer.

Pipe Size	No. of 36 in. Straps Required*
1...9 in. (25...225 mm)	1
10...19 in. (250...480 mm)	2
20...29 in. (500...740 mm)	3
30...39 in. (760...1000 mm)	4

Table 4: Straps required per pipe size

NOTE: *Table 4 indicates the number of straps required to mount one transducer. For transit time installations, two transducers must be mounted.

Doppler transducers are mounted either opposite each other or side-by-side and considered a single transducer for calculating the number of straps required.

DISPLAY OPERATION AND CONFIGURATION

CAUTION

THE DXN IS DESIGNED TO OPERATE FOR EXTENDED PERIODS WITH FREE AIR MOVEMENT TO COOL THE METER. THE UNIT SHOULD NOT BE OPERATED FOR MORE THAN 30 MINUTES IN A CLOSED CASE INCLUDING THE CANVAS CARRYING CASE.

IMPORTANT

The screen should be cleaned only with the cleaning kit supplied. Do not use common cleaning chemicals such as glass cleaner. Clean the exterior surfaces of the meter using a clean, soft cloth and water.

Menu Conventions

The DXN uses a sophisticated *Group > Page* layout for navigation. The tabbed menu tree provides access to all controls and settings using a *Group Tab* name > *Page* name.

When navigating the DXN menus, select a *Group* tab and a *Page* name. For example, to navigate to *Main > Alerts*, press the *Display* tab, then press on the *Alerts* page.

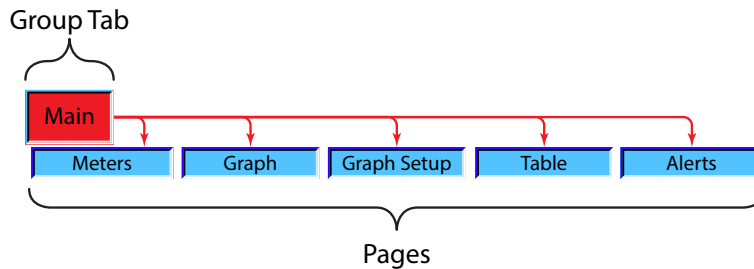

Figure 39: Group > page format

Main Screen

The DXN main screen contains all the controls needed to manipulate the user interface. The meter uses buttons, drop-down lists and scroll bars to configure meter functions.



Figure 40: Main display screen

Status Bars

The status bar arrow key, in the bottom left corner, controls which status bars are displayed. Each press of the arrow key scrolls to the next control or display.



Figure 41: Status bars

The Quick Status Bar also has a segment that does double duty as a button that functions as a toggle as well.



Figure 42: Status bar button

Use the left icons on the Quick Status Bar turn ON/OFF the *Full Screen* mode. The Quick Status Bar also has a number of shortcuts leading to some of the most referenced menu screens.



The *Battery* icon brings up the *System > Power* screen, showing real time battery condition.



The *Communications* icon brings up the *System > Comm* screen, showing continuous data being output to the active serial port.



The *Status* icon indicates new communication or change in the flow meter settings.



The *Datalogger* shortcut brings up the *Log > Setup* control screen, allowing quick access to the datalogger controls.

MAIN GROUP

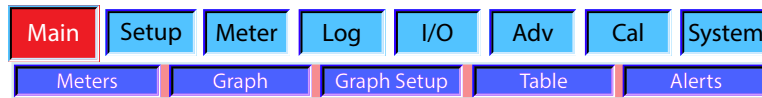

Figure 43: Main group

Meters Page

The *Meters* page displays system data, such as the current reading and units of measurement.



Figure 44: Main > Meters

The DXN can show up to four parameters sub-screens on the main screen. The number of individual sub-screens shown is controlled by the *Main > Meters* button.

To change the number of sub screens shown:

1. Press the **Meters** page tab until the desired number of screens display.
2. Press **Full Screen** on the Quick Status Bar to turn the full screen function ON or OFF (See *Figure 42*).

NOTE: Currently 1, 3, or 4 parameters can be seen on the screen at a time.

To change which parameters display, press the combo box in the upper left corner of each screen or sub-screen. Press the down arrow to expand the drop-down list and select a parameter. *Figure 45* shows an example of the drop-down list.

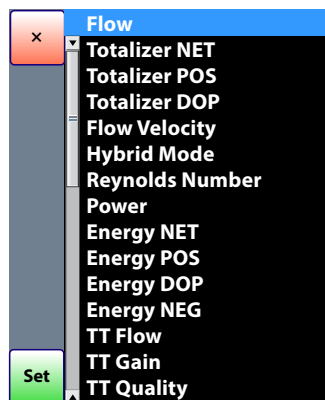

Figure 45: Sample drop-down list

Table 5 shows the metering parameter choices.

Flow	Energy NET	DOP Quality	TT Aperture Start
Totalizer NET	Energy POS	TT Flow Velocity	RTD1 Temperature
Totalizer POS	Energy DOP	TT Delta T	RTD2 Temperature
Totalizer NEG	Energy NEG	TT Delta T Raw	RTD Delta Temp
Totalizer DOP	TT Flow	TT TOF Bias Raw	IO Voltage In
Flow Velocity	TT Gain	TT TOF Fluid	IO Digital In
Hybrid Mode	TT Quality	TT Fluid SOS	IO Voltage Out
Reynolds Number	DOP Flow	DOP Flow Velocity	IO Current Out
Power	DOP Gain	DOP Frequency	IO Digital Out

TT = Transit Time DOP = Doppler

Table 5: Meters drop-down menu choices

Graph Page

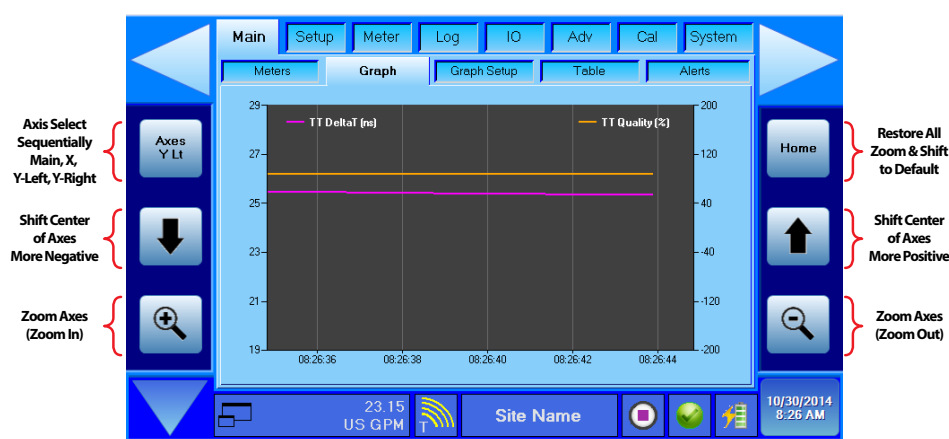

Figure 46: Main > Graph

Axes Scaling Buttons

Control of the axis scaling is performed with the axes scaling buttons. Pressing the Axes button successively moves through the three axis configuration choices as shown in Figure 47.

The X axis is always time-based. The (Zoom In) or (Zoom Out) buttons expand or contract the timeline shown on the horizontal (X axis). The minimum graph time period is 10 seconds and the maximum is 1 year.

The and functions control the scale of the left and right sides of the graph, respectively.

The (Zoom In) and (Zoom Out) buttons work in the same fashion as on the X axis except that on the **Y Lt** and **Y Rt** axis they expand or contract the range of the vertical scaling.

The (Scroll Up) and (Scroll Down) buttons shift the zero point of the graph up or down.

The (Home) button resets the graph to the parameters set using the *Main > Graph Setup* screen.

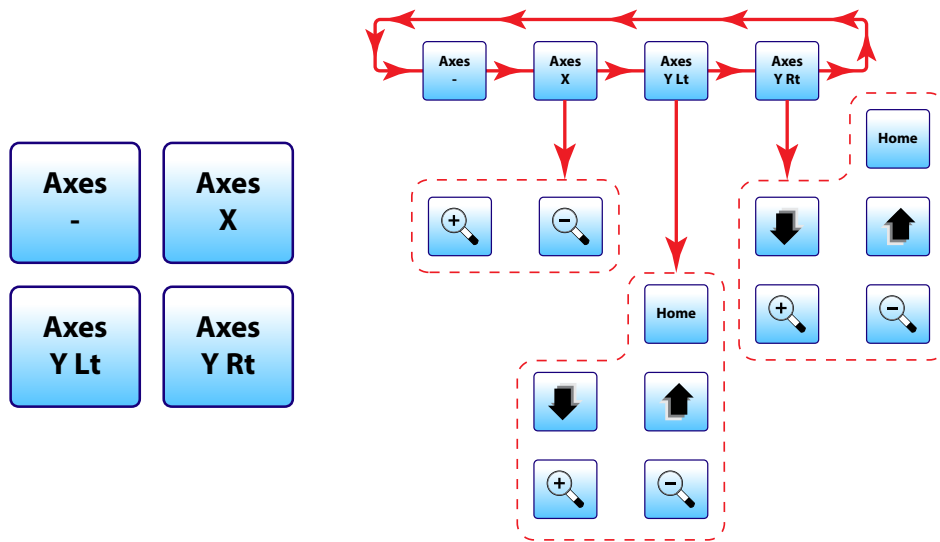

Figure 47: Graph axis configuration

Graph Setup Page

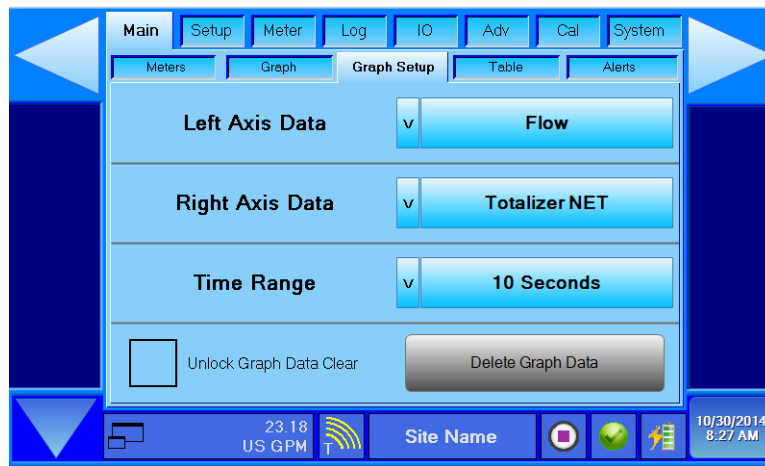

Figure 48: Main > Graph setup

Left and Right Axis Data

The *Left and Right Axis Data* controls which parameters are shown on the respective axis. See *Table 6* for parameter choices. When you press the control, a drop-down menu appears. Highlight a parameter with the blue box and press **Set** to load the parameter. Press **X** to exit the drop-down menu.

Flow	Energy NET	DOP Quality	TT Aperture Start
Totalizer NET	Energy POS	TT Flow Velocity	RTD1 Temperature
Totalizer POS	Energy DOP	TT Delta T	RTD2 Temperature
Totalizer NEG	Energy NEG	TT Delta T Raw	RTD Delta Temp
Totalizer DOP	TT Flow	TT TOF Bias Raw	IO Voltage In
Flow Velocity	TT Gain	TT TOF Fluid	IO Digital In
Hybrid Mode	TT Quality	TT Fluid SOS	IO Voltage Out
Reynolds Number	DOP Flow	DOP Flow Velocity	IO Current Out
Power	DOP Gain	DOP Frequency	IO Digital Out

TT = Transit Time DOP = Doppler

Table 6: Y Lt and Y Rt axis parameter choices

Time Range

The *Time Range* control selects a period to be shown on the X axis. See *Table 7* for the time choices. When you press the control, a drop-down menu appears. Highlight a parameter with the blue box and press Set to load the parameter. Press X to exit the drop-down menu.

10 Seconds	30 Minutes	1 Day	14 Days
30 Seconds	1 Hour	5 Days	1 Month
1 Minute	5 Hours	7 Days	6 Months
10 Minutes	10 Hours	10 Days	1 Year

Table 7: Time Axis Choices

Delete Graph Data

To clear any current graphing data and return the graph scaling to factory defaults, first press **Unlock Graph Data Clear**. A green checkmark appears and the *Delete Graph Data* button turns red.

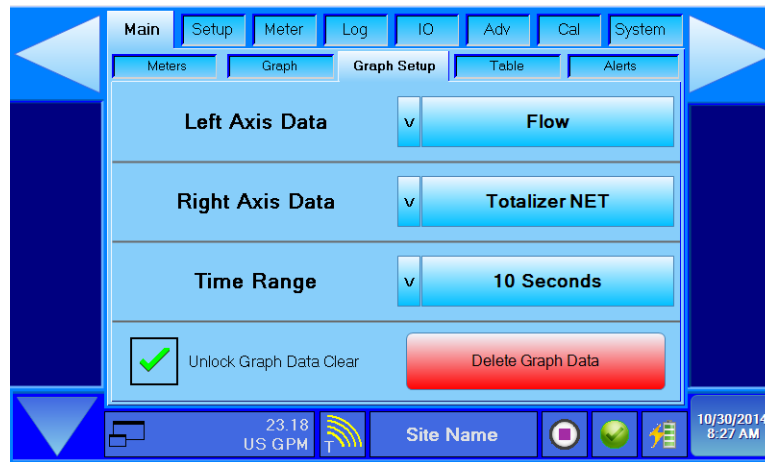

Figure 49: Delete graph data

Press **Delete Graph Data**. The graph resets to factory defaults and the *Delete Graph Data* button turns gray.

Table Page

The screenshot shows the 'Table' page with a scrollable list of measurements. The status bar at the bottom shows '23.22 US GPM' and the date '10/30/2014 8:27 AM'.

Measurement	Value	Units
Flow	23.221	US GPM
Totalizer NET	304.0	US Gallons
Totalizer POS	304.0	US Gallons
Totalizer NEG	0.0	US Gallons
Totalizer DOP	0.0	US Gallons
Flow Velocity	2.522	FPS
Hybrid Mode	1	
Reynolds Number	37874	
Power	0.00	Watts
Energy NET	0.0	BTU
Energy POS	0.0	BTU
Energy NEG	0.0	BTU
Energy DOP	0.0	BTU
TT Flow	23.19	US GPM

Figure 50: Main > Table

The *Table* page shows all the current values the meter is tracking along with their respective units. The scroll bar on the right side of the page is used to scroll up or down the list until the required parameter is found.

Alerts Page

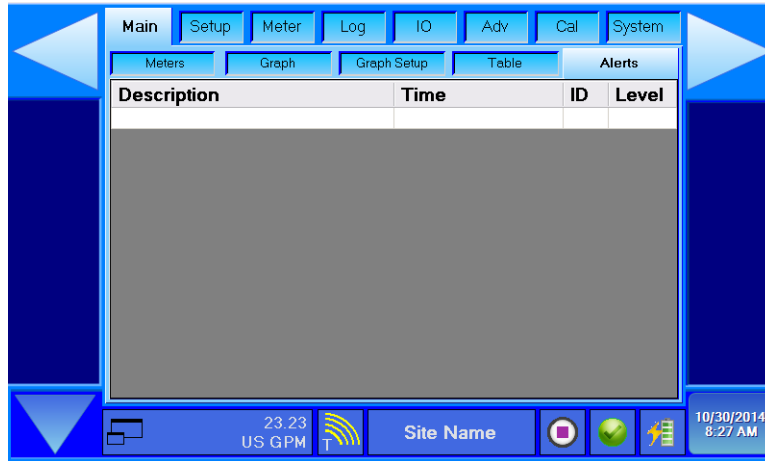

Figure 51: Main > Alerts

The *Alerts* page keeps track of any abnormal conditions encountered by the meter. Such things as battery condition, unit temperature issues, low signal quality episodes and fluid sound speed problems are shown in the alerts page until they are resolved.

The severity of the condition is indicated by the color of the description. Red colored descriptions are the most serious with orange being moderate severity and yellow depicting low severity.

Red	Serious	Immediate Action Required
Orange	Moderate	Cautionary
Yellow	Minor	Minor

SETUP GROUP

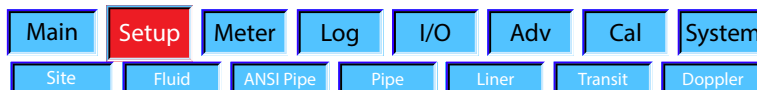

Figure 52: Setup group

The Setup group is used to create and store individually configured metering locations. Each new location can be stored with all the setup parameters for that particular site, making periodic measurements less time consuming.

New sites can be created in two different ways. A site can be created using the factory default settings or the settings the meter is currently using. In either case, settings can be changed for that particular site whenever necessary.

Site Page

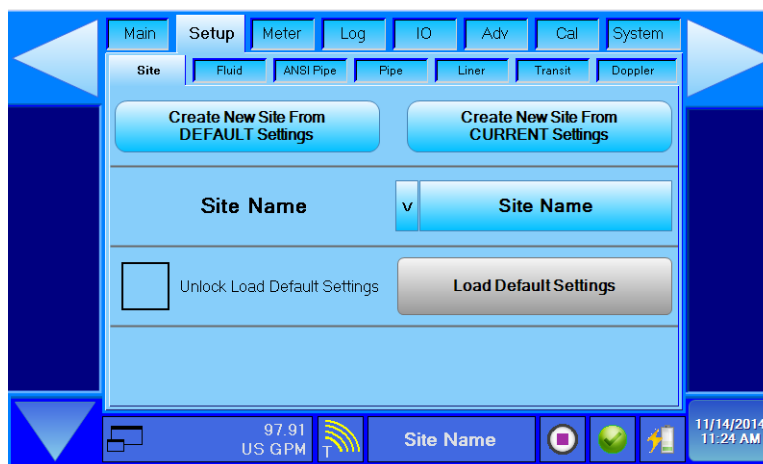

Figure 53: Site page configuration

Create New Site from DEFAULT Settings (Alphanumeric Entry)

To create a new site using the meters default settings:

1. Press **Create New Site From DEFAULT Settings**. The alphanumeric keypad displays.
2. Type in a unique name (restricted to 45 characters) for the site and press **Create Site**.

The meter's default settings are copied from memory and stored under the new site name. The *Site Name* button also shows the new site name.

Create New Site from CURRENT Settings (Alphanumeric Entry)

To create a new site using the meter's current settings:

1. Press **Create New Site From CURRENT Settings**. The alphanumeric keypad displays.
2. Type in a unique name (restricted to 45 characters) for the site and press **Create Site**.

The meter's current settings are stored under the new site name. The *Site Name* button also shows the new site name.

This function is used when the meter is completely set up and operating as required. Once all parameters have been optimized, all the settings are saved under the new site name, making the setup of the same site much faster in the future.

Site Name

The *Site Name* function has a drop-down list of all existing site names that have been programmed into the meter.

Highlight a site name and press **Set** to activate it. If a large number of sites have been stored use the scroll bars to locate the site. To exit the drop-down menu without making any changes,  (*Cancel*).

Load Defaults Settings

Loading the factory defaults returns the meter to a known state for most of the customer-selectable parameters. The default settings do not include basic setup parameters such as pipe size, pipe type, and fluid type. To prevent unintended loading of the default settings, you must check the *Unlock Load Default Settings* box to activate the *Load Default Settings* function.

1. Press **Unlock Load Default Settings**. A green checkmark appears and the *Load Default Setting* button turns orange.
2. Press **Load Default Settings**. When the settings have been loaded, the *Load Default Settings* button turns gray and the green checkmark disappears from the *Unlock Load Default Settings* box.

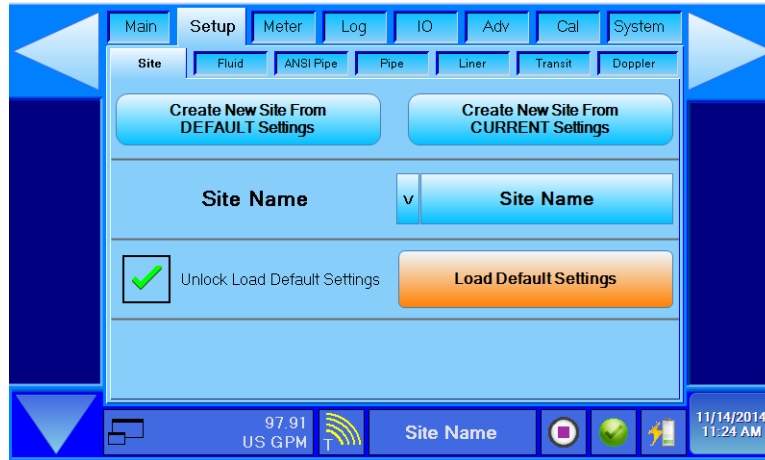

Figure 54: Load default settings enabled

Fluid Page

Select **Setup** from the *Group* bar at the top of the screen. When the site page appears, select the **Fluid** page to enter information about the type of fluid to be used.

NOTE: Use the *Fluid* page also to start the entry of information about a custom fluid.



Figure 55: Fluid setup

NOTE: Use the scroll bars to the right of the menu choices to display more information than can be seen on one page. To navigate the *Fluid* page, use the *Up/Down* arrow keys or the scroll bar.

Fluid

Choose the fluid material from the drop-down list.

Water – Tap	Ethanol	Isopropanol	Oil Diesel #1	Propylene Glycol 50%
Water – Black	Ethylene Glycol 100%	Jet Fuel A1/JP8	Oil Diesel #2	Propylene Glycol 25%
Acetone	Ethylene Glycol 50%	Jet Fuel B/JP4	Oil Hydraulic (Petro)	Stoddard Solvent
Ammonia	Ethylene Glycol 25%	Kerosene	Oil Lubricating	Water – Distilled
Benzene	Gasoline	Methanol	Oil Motor (SAE 20/30)	Water – Sea
Brine	Glycerin	Milk 4%	Propylene Glycol 100%	Custom

Table 8: Fluid material choices

This list is provided as an example. Additional fluids are added periodically. Select a fluid from the list or select **Custom**, if the fluid is not listed.

When you select a fluid from the list, the system automatically loads a nominal value for speed of sound, specific gravity, viscosity, and specific heat capacity for that material. If actual values are known for the specific fluid system and those values vary from the pre-defined numbers, you can revise the value by selecting the **Custom** fluid choice and entering the values.

Custom Fluids

When you select **Custom** from the *Fluid* list, you must enter the appropriate values for sound speed, specific gravity, viscosity and specific heat capacity.



Figure 56: Custom fluid setup

Custom Fluid Sound Speed (Numeric Value)

Enter the sound speed of the custom fluid. If *English* is used for the *Entry Units* enter the sound speed in fps. If *Metric* is used the sound speed is entered in mps. The fluid sound speed is also obtained directly from the meter if the transducers are already correctly positioned and the signal quality is above 10%. This value is available by selecting *TT SOS* in one of the data panels. See *Figure 55*.

Custom Fluid Specific Gravity (Numeric Value)

DXN flow meters use pipe size, specific gravity and viscosity to calculate Reynolds numbers. Since the Reynolds number influences flow profile, the DXN has to compensate for the relatively high velocities at the pipe center during transitional or laminar flow conditions. The *Specific Gravity* entry is used in the calculation of Reynolds and the resultant compensation values.

The *Specific Gravity* entry allows adjustments to be made to the specific gravity (density relative to water) of the liquid.

As stated previously specific gravity is used in the Reynolds correction algorithm. It is also used if mass flow measurement units are selected for rate or total.

If a fluid is chosen from the *Fluid Material* list, a nominal value for specific gravity in that media is automatically loaded. If the actual specific gravity is known for the application fluid and that value varies from the automatically loaded value, the value can be revised.

If a custom fluid is entered, a specific gravity needs to be entered if mass flows are calculated. See "*Fluid Properties*" on page 110.

Dynamic Viscosity (Numeric Value Entered in cP)

If a fluid was chosen from the Fluid Material list, a default viscosity is automatically loaded. If the actual viscosity of the liquid is known or it differs from the default value, the value can be revised. A list of alternate fluids and their associated viscosities is located in the Appendix of this manual.

Viscosity is a measure of the resistance of a fluid to deform under either shear stress or extensional stress. It is commonly perceived as thickness, or resistance to flow. Viscosity describes a fluid's internal resistance to flow and may be thought of as a measure of fluid friction.

The cgs (centimeters - grams - seconds) system uses a unit of dynamic viscosity called the poise (P). It is more commonly expressed, particularly in ASTM standards, as centipoise (cP). The centipoise is commonly used because water has a viscosity of 1.0020 cP (at 68° F (20° C); the closeness to one is a convenient coincidence).

The DXN uses dynamic viscosity, expressed in cP, in the calculation of Reynolds numbers and its Reynolds correction algorithm.

Specific Heat Capacity – (Numeric Value entered in kJ/kg x °K)

Allows adjustments to be made to the specific heat capacity of the liquid.

If a fluid from the Fluid Material list is chosen, a default specific heat is automatically loaded. If the actual specific heat of the liquid is known or it differs from the default value, the value can be revised. A list of alternate fluids and their associated specific heat capacities is located in the Appendix of this manual. Enter a value that is the mean of both pipes.

Heat capacity or thermal capacity, is the physical quantity that characterizes the amount of heat required to change a substance's temperature by a given amount. The SI unit of heat capacity is expressed in joules per degree kelvin (J/°K).

The specific heat capacity, often simply called specific heat, is the heat capacity per unit mass of a material. Occasionally, in engineering contexts, a volumetric heat capacity is used. The quantity used in the DXN is calculated as:

$$\text{Specific Heat Capacity} = \frac{kJ}{kg \times ^\circ K}$$

ANSI Pipe Page

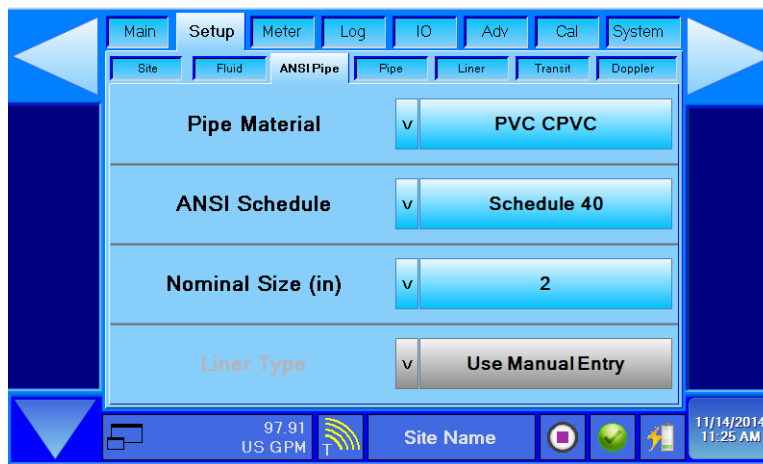

Figure 57: Setup > ANSI Pipe

The *ANSI Pipe* page provides access to built-in pipe tables. The pipe lookup tables use cascading options to make selections. When you select **Pipe Material**, the *ANSI Schedule/Class* option becomes available. When you select **ANSI Schedule/Class**, the *Nominal Size* option becomes active.

The *Setup > ANSI Pipe* and *Setup > Pipe* drop-down lists interact with each other. When you select a parameter in one drop-down list, that parameter becomes unavailable in the other drop-down list.

Select **Use Manual Entry** for *Pipe Material* to enter non-standard parameters. Choosing *Use Manual Entry* unlocks the *Pipe Material*, *Pipe OD*, and *Pipe Wall [Thickness]* options (see Figure 60) on the *Setup > Pipe* page.

Pipe Material

Choose the pipe material from the combo box drop-down list.

Manual Dimension Entry	Iron - Cast	St Steel 304L
Aluminum	Iron - Ductile	St Steel 316
Brass (Naval)	PVC CPVC	St Steel 347
Carbon Steel	St Steel 302/303	St Steel 410
Copper	St Steel 304	St Steel 430

Table 9: Pipe material choices

NOTE: This list is provided as an example. Additional pipe materials are added periodically.

Pipe Schedule/Class

The choice of pipe material determines the options available in the *Schedule/Class* drop-down list. For example, if you select a pipe material that is governed by ANSI standards, the option label is *ANSI Schedule* and the schedule choices are appropriate for ANSI pipe. If you select **Cast Iron**, the options label is *Class* instead of *Schedule*, indicating the pipe material is categorized in classes.

Nominal Size

The *Nominal Size* option has a drop-down list of standard or nominal pipe sizes from which to choose.

Liner Schedule – Restricted Choice

Some combinations of Pipe Material, Class and Nominal Size have liner information built into the pipe specification. This condition is usually found in ductile iron classes, 6 inches and up. If a ductile pipe with built-in liner is used, a selection of either *Standard* or *Double* can be made.

NOTE: Choosing *Standard* or *Double* disables the *Setup > Liner* option.



Figure 58: ANSI pipe page manual entry

If you select the *Manual Dimension Entry* option in *Setup > ANSI Pipe* (see Figure 57), the parameters in the *Setup > Pipe* page become available. See Figure 60.

NOTE: If you use the *Setup > ANSI Pipe* feature, the values you enter are automatically loaded into the parameter choices in the *Setup > Pipe* screen.

Pipe Page



Figure 59: Pipe page from nominal entry

Use the *Setup > Pipe* page to manually enter pipe parameters. If you used the lookup function in *Setup > ANSI Pipe*, nominal values for *Pipe OD*, *Pipe Wall [Thickness]* and *Roughness* are automatically entered. If the actual values of the pipe differ from the ones automatically entered, go back to *Setup > ANSI Pipe* and select **Manual Dimension Entry** to enter non-standard parameters. Selecting *Manual Dimension Entry* unlocks the *Pipe Material*, *Pipe OD* and *Pipe Wall [Thickness]* inputs as shown in Figure 60.



Figure 60: Pipe page allowing manual entry

Pipe Material

When a pipe material is chosen from the Pipe Material list, a nominal value for speed of sound in that material and the pipe roughness are automatically loaded.

Pipe OD (Numeric Value)

Enter the Pipe OD (outside diameter) in inches for English units or in millimeters for Metric units.

NOTE: Charts listing popular pipe sizes have been included in this manual. Correct entries for pipe O.D. and pipe wall thickness are critical to obtaining accurate flow measurement readings.

Pipe Wall [Thickness] (Numeric Value)

The Pipe Wall thickness is the value of the actual pipe wall thickness excluding any liner that may be present.

NOTE: Accurate values for Pipe OD and Pipe Wall thickness are necessary for accurate computation of the volumetric flow rate. Without accurate pipe data, flow rates will be in error by the difference between the actual pipe cross sectional area and the area calculated using the incorrect pipe OD or pipe wall thickness values.

Pipe Wall Thickness Gauge Automatic Use

NOTE: There are two different “reference” measurement methods required depending on the type of pipe being used. With **Tubing** the reference is checked with the transducer **ON** pipe, for all other pipe types the reference is set with the transducer **OFF** the pipe.

NOTE: Pipe thickness transducer must be applied perpendicular to the long axis of the pipe/tube (See Figure 64).

1. Make sure Setup > ANSI Pipe > ANSI Schedule is set to “Use Manual Entry” as in Figure 61.

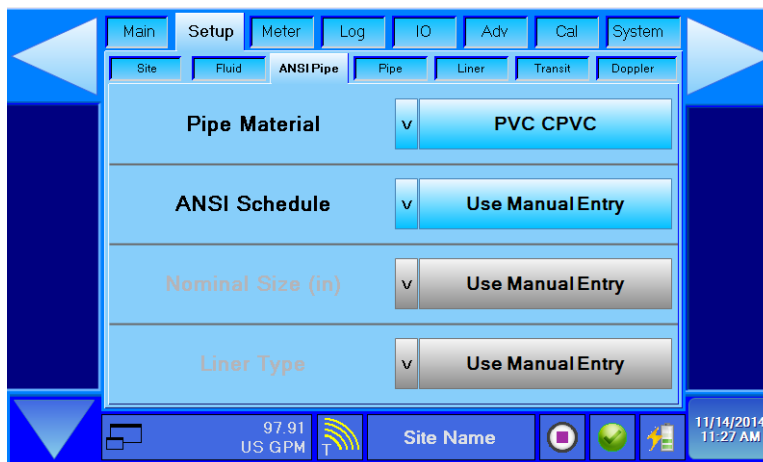

Figure 61: Setup > Pipe US — schedule manual entry selected

2. In the *Setup > Pipe* screen, make sure that the *Pipe Material* and *Pipe OD* have been entered as in *Figure 62*.
3. The pipe wall thickness gauge uses the same input connectors as the transit time ultrasonic transducers. The thickness gauge has two BNC connectors with red and blue markings. Connect the pipe wall thickness transducer to the DXN matching the red and blue BNC plugs to the red and blue transit time inputs.

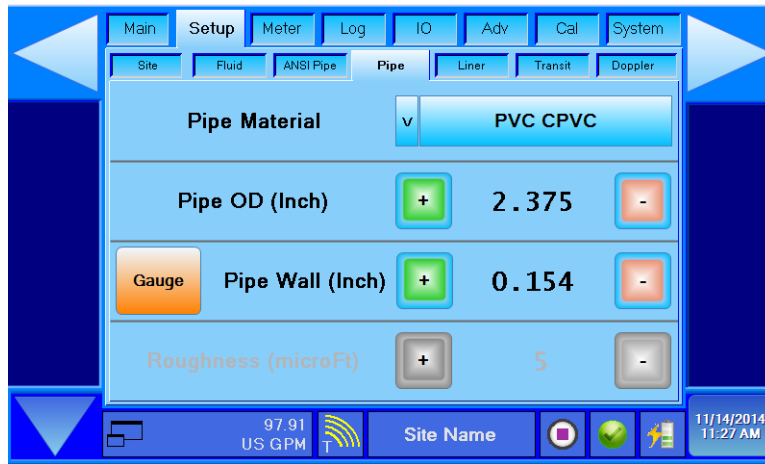

Figure 62: Setup > Pipe

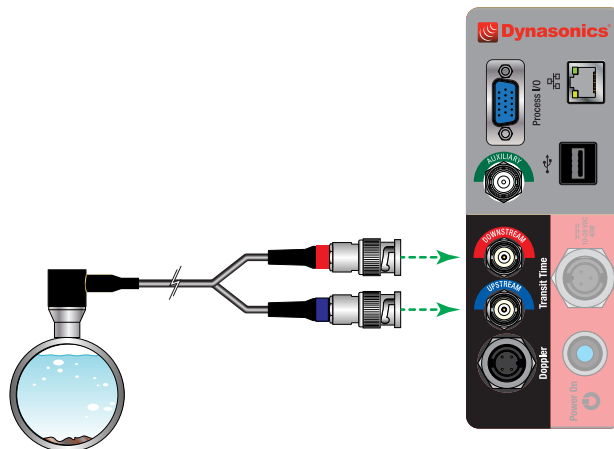

Figure 63: Pipe thickness gauge connections

2. From the *Setup > Pipe* screen, press **Gauge** to enter the pipe gauge wizard (see *Figure 62*). The Ultrasonic Thickness Gauge wizard appears in *Automatic Analysis Mode*.

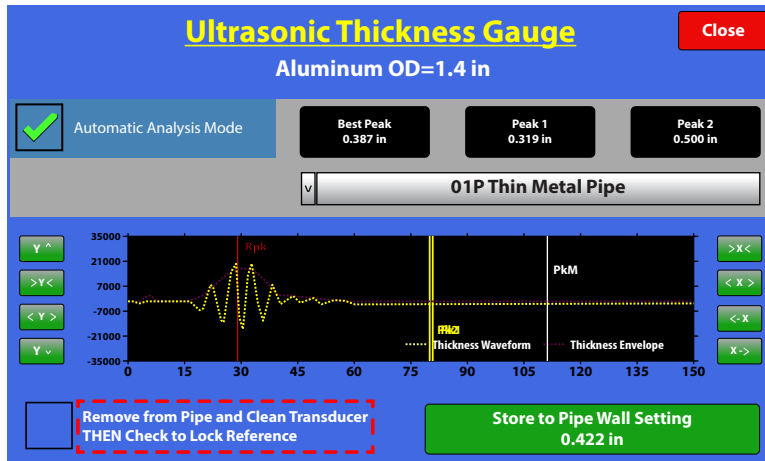

Figure 64: Pipe thickness gauge wizard screen

3. Before applying couplant and putting the transducer on the pipe, wait for the waveform to stabilize (about 2...4 seconds).

If measuring pipe with wall thickness greater than about 0.1 in. or 2.5 mm:

- Press the **Remove from Pipe and Clean Transducer** check box. A checkmark appears in the check box and the *Red-Rpk* line in the waveform display stops moving. This locks the reference.
- Apply couplant to pipe/transducer and apply the transducer to the pipe so that the cable is perpendicular to the pipe (as well as the alignment line on the bottom of the transducer). The waveform and measurements settle in a few seconds.

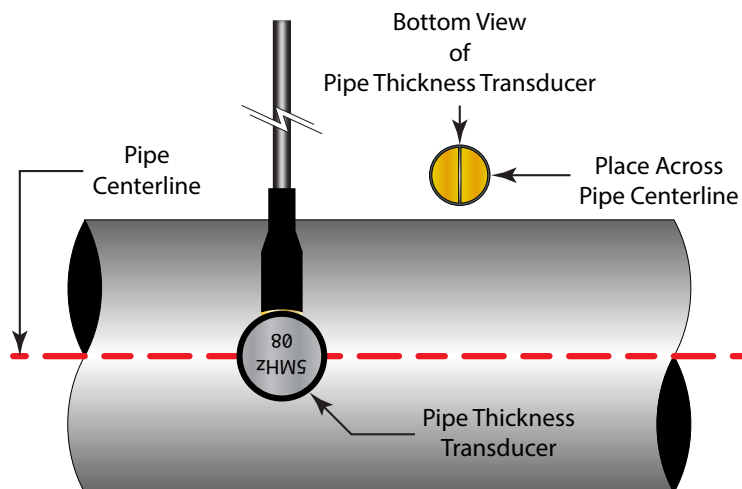

Figure 65: Thickness gauge transducer positioning

- The inside of the green button in the lower right of the screen shows the pipe wall thickness measurement.
- Lastly **Press** the green measurement button to store pipe thickness to *Setup > Pipe > Wall Thickness*.

If measuring copper tubing or other types of metal tubing with wall thickness less than 0.1 in. or 2.5 mm:

- Apply couplant to pipe/transducer and apply transducer to pipe so the cable is perpendicular to the pipe (as is the notch in the transducer). The waveform settle in a few seconds.

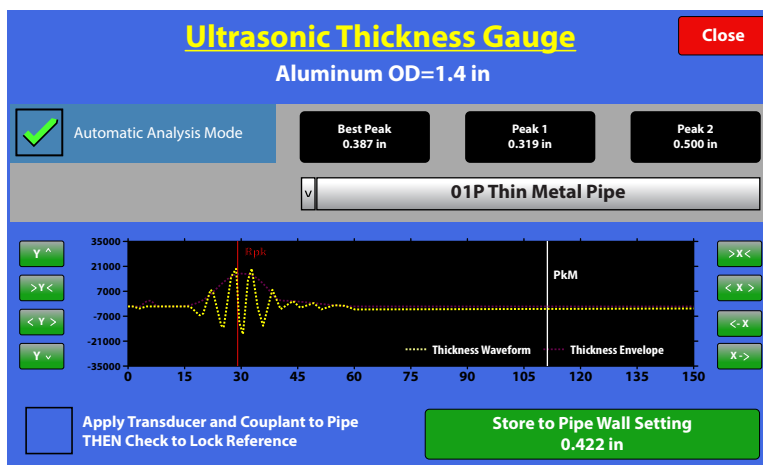

Figure 66: Tubing thickness gauge wizard screen

- Press **Apply Transducer and Couplant to Pipe** check box. A check appears in the box and the *Red-Rpk* line in the waveform display stops moving. This locks the reference.
- The inside of the green button in the lower right of the screen shows the pipe wall thickness measurement.
- Press the green measurement button to the store pipe thickness to *Setup > Pipe > Wall Thickness*.

Advanced Mode

The advanced mode is intended users with knowledge of ultrasonic testing or when automatic settings are not appropriate. To enter *Advanced Mode*, uncheck **Automatic Analysis Mode**. The manual settings reflect the automatic settings when the wizard first opens.

You can select the type of waveform and analysis from the pull-down menu. The first two digits represent how many signal periods are transmitted, and the text indicates the analysis used in making the measurement:

01P Metal Tubing	1 Pulse	Tubing Mode
01P Thin Metal Pipe	1 Pulse	Thin Pipe Mode/ Pipe Mode
02P Generic Metals	2 Pulse	Pipe Mode
03P Plastics, Iron Pipe	3 Pulses	Pipe Mode
05P Thick Plastics, Ceramics, Mortar	5 Pulses	Pipe Mode
15P Very Thick	15 Pulses	Pipe Mode

Table 10: Pipe mode explanations

In *Pipe Mode*, you must lock the reference signal **BEFORE** applying the transducer to the pipe. Ultrasonic transit time is measured as the difference in time from the ultrasound leaving the transducer face to the first reflection from the fluid-pipe interface. The reference is detected as the large peak below a timed threshold. The largest amplitude peak is used as the first reflection.

In *Thin Pipe Mode*, you must also **lock** the reference signal **BEFORE** applying the transducer to the pipe.

In *Tubing Mode*, you must lock the reference **AFTER** applying the transducer is to the pipe. Ultrasonic transit time is measured as the difference in time between two adjacent-in-time signal reflections. The largest amplitude peak is used as the reference, Peak 1 and Peak 2 are any detected adjacent peaks to the reference.

Supplementary Information

- Expected error is about 1.5% + 15 mils or 1.5% + 0.4 mm
- Measurement under 0.1 in. or 2.5 mm is difficult and requires special techniques (*Tubing Mode* and *Thin Pipe Mode*).
- Does not measure liner thickness.
- May not always work on all materials, conditions and fluids.
 - ◊ In thin metal and metal pipe modes, the reference can disappear from the display once the transducer is applied to the pipe. This is why the reference is locked prior to placement on pipe.

[Pipe] Roughness (Numeric Value in Micro Feet)

Surface roughness is the measure of the small surface irregularities in the pipe surface and is composed of three components: roughness, waviness and form. These are the result of the manufacturing process employed to create the surface.

Surface roughness average (Pipe R), also known as arithmetic average (AA) is rated as the arithmetic average deviation of the surface valleys and peaks expressed in micro inches (μ inches).

The DXN provides flow profile compensation in its flow measurement calculation. One of the components of that calculation is roughness. The ratio of average surface imperfection as it relates to the pipe internal diameter is used in this compensation algorithm and is found by using the following formula:

$$\text{Pipe R} = \frac{\text{RMS Measurement of the Pipes Internal Wall Surface}}{\text{Inside Diameter of the Pipe}}$$

NOTE: A microinch (μ inch) is one millionth (1/1,000,000) of an inch.

If a pipe material was chosen from the Pipe Material list, a nominal value for relative roughness in that material is automatically loaded.

If the pipe has a roughness value that differs from standard for the pipe type, a custom value can be entered using the Roughness controls.

Liner Page



Figure 67: Setup > Liner page

Liner Material

Choose the pipe liner material from the drop-down list.

The following list is an example. Additional materials are added periodically. Select the liner material from the list. If the exact liner material is not listed, choose one that most closely represents it.

None	Mortar	Polystyrene
Acrylic	HD Polyethylene	Rubber
Asbestos Cement	LD Polyethylene	Tar Epoxy
Ebonite	Polypropylene	Teflon® (PFE)

Table 11: Liner material choices

Liner Wall

Enter the liner wall thickness in inches for English units or millimeters for Metric units.

NOTE: If a liner is present, an accurate value for Liner Wall thickness is necessary for accurate computation of the volumetric flow rate. Without accurate liner data, flow rates will be in error by the difference between the actual pipe cross sectional area and the area calculated using the incorrect pipe liner thickness.

Liner Roughness

When you select a liner material from the *Liner Material* list, the system automatically loads a nominal value for relative roughness in that material.

Transit Page

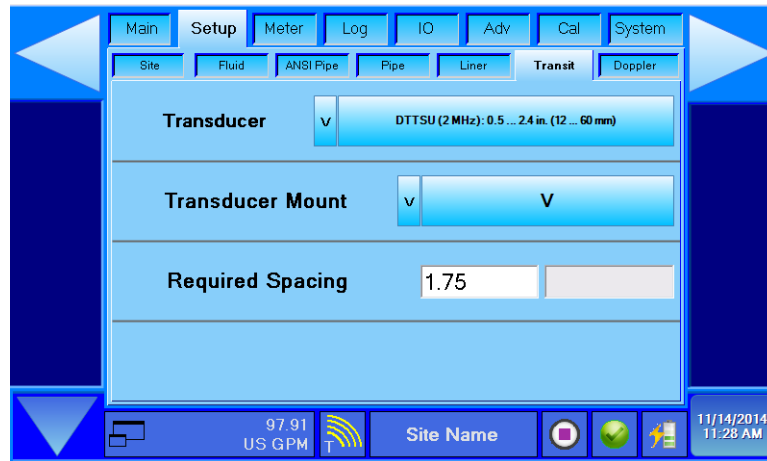

Figure 68: Setup > Transit

Transducer

Select a transducer from the drop-down list. Transducer transmission frequencies are specific to the type of transducer.

Transducer	Frequency	Type	Use for Pipe Sizes
DTTR/DTTN	1 MHz	Standard Transducers	2...98 in. (50...2500 mm)
DTTH		High Temperature Transducers	
DTTL	0.5 MHz	Large Pipe Transducers	> 16 in. (400 mm)
DTTSU	2 MHz	Small Pipe Transducers	0.5...2 in. (13...50 mm)

Table 12: Transducer types and frequencies

Transducer Mount

Select the mounting pattern for the transducers from the drop-down list. An appropriate mounting pattern is based on pipe and liquid characteristics.

The DXN transit time flow meters can be used with these transducer types: DTTR, DTTN, DTTH, DTTL and DTTSU. The DTTR, DTTN, DTTH or DTTL transducer sets consist of two separate sensors that function as both ultrasonic transmitters and receivers. DTTSU transducers integrate both sensors into one assembly. All transducers require the separation of the transmit/receive modules be adjusted to the spacing value calculated during the DXN flow meter setup. DTTR, DTTN and DTTL transducers are clamped on the outside of a closed pipe at a specific distance from each other.

The DTTN and DTTL transducers can be mounted in:

- W-Mount, where the sound traverses the pipe four times. This mounting method produces the best relative travel time values but the weakest signal quality.
- V-Mount, where the sound traverses the pipe twice. V-Mount is a compromise between travel time and signal quality.
- Z-Mount, where the transducers are mounted on opposite sides of the pipe and the sound crosses the pipe once.
- Z-Mount, which yields the best signal quality but the smallest relative travel time.

See *Table 2 on page 24* for transducer mounting mode selection starting points.

Required Spacing

The spacing required between transducers is calculated by the firmware after all pipe parameters have been entered. The value represents the one-dimensional linear measurement between the transducers (the upstream/downstream measurement that runs parallel to the pipe). This measurement is taken between the lines that are scribed into the side of the transducer blocks. The value is in inches for English or millimeters for Metric.

For DTTR or DTTN transducers that are mounted using the transducer track assembly, place one transducer at the 0 mark etched into the track and the other at the calculated measurement.

Doppler Page



Figure 69: Doppler transducer selection

To use the Doppler measuring, select the DT94 series transducers. At this time, the DT94 series are the only Doppler transducers supported.

METER GROUP

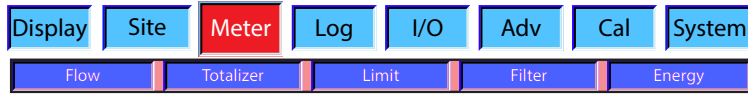

Figure 70: Meter group

Select the Meter Group from the Group bar at the top of the screen. When the Meter pages appear select the flow page to enter information about the flow units to be used.

Flow Page

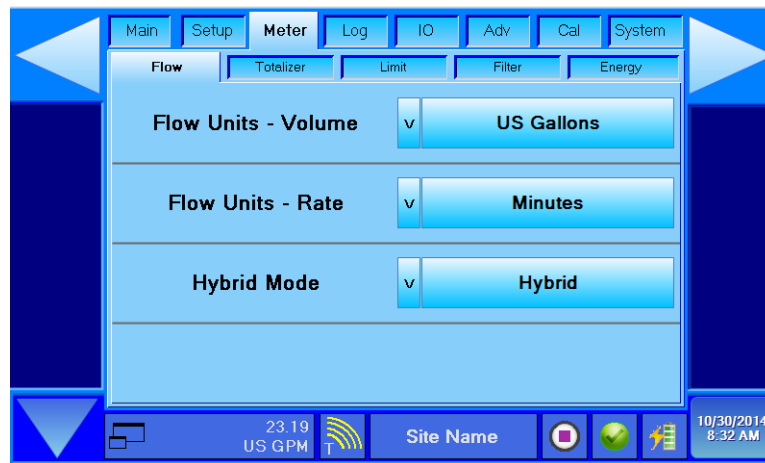

Figure 71: Flow units setup

Flow Units Volume

Select an engineering unit for flow rate measurements:

US Gallons	Cubic Feet	Oil Barrels (42 Gallons)	Meters
Liters	Cubic Meters	Liquid Barrels (31.5 Gallons)	Pounds
Mega US Gallons	Acre Foot	Feet	Kilograms

Table 13: Flow units

Flow Units Rate

Select a time interval for flow rate measurements:

- Seconds
- Minutes
- Hours
- Days

Transmission Mode

Select the type of ultrasonic signal for the flow meter to generate:

- Hybrid – The DXN flow meter monitors the fluid conditions and determines automatically when to switch between Doppler and transit time modes. Both transit time and Doppler transducers must be installed and connected.
- Transit Time – The DXN flow meter always operates in transit time mode.
- Doppler – The DXN flow meter always operates in Doppler mode.

Totalizer Page

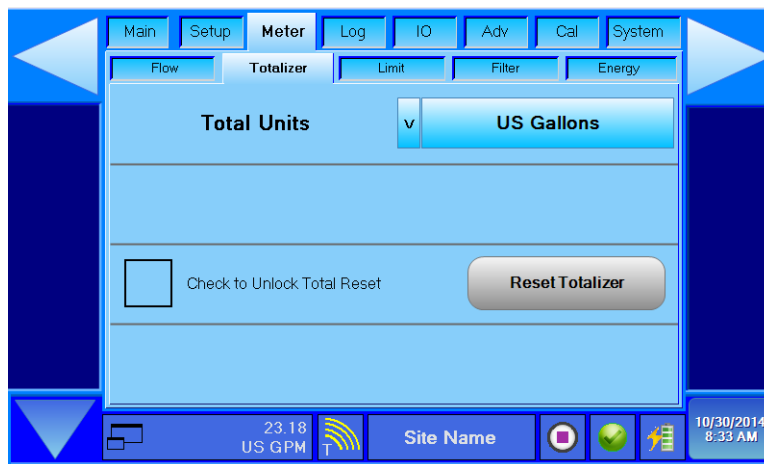

Figure 72: Totalizer setups

Total Units

From the pull-down list, select an engineering unit for flow accumulator (totalizer) measurements.

US Gallons	Acre Foot
Liters	Oil Barrels (42 Gallons)
Mega US Gallons	Liquid Barrels (31.5 Gallons)
Cubic Feet	Feet
Cubic Meters	Meters

Table 14: Totalizer units

Totalizer Reset

Totalizer Reset function resets all totalizers back to zero. To prevent inadvertent resets, a totalizer lock is provided.

To reset the totalizers:

1. Press **Check To Unlock Total Reset** box (See Figure 72). A checkmark appears in the box. The *Reset Totalizer* option becomes active.
2. Press **Reset Totalizer** to return all totalizers to zero.

NOTE: The DXN flow meter also has a hardware totalizer reset function.

Limit Page



Figure 73: Limit value settings

Min Flow Limit

A minimum rate setting establishes the filter software parameters and the lowest rate value to display. Volumetric entries display in the *Flow Units* selected in *Meter > Flow*.

- For unidirectional measurements, set the **Min Flow Limit** to zero.
- For bidirectional measurements, set the **Min Flow Limit** to the highest negative (reverse) flow rate expected in the piping system.

The flow meter does not display a flow rate at flows less than the *Min Flow Limit* value. As a result, if the *Min Flow Limit* is set to a value greater than zero, the flow meter displays the *Min Flow Limit* value, even if the actual flow/energy rate is less than the set *Min Flow Limit*.

For example, if the *Min Flow Limit* is set to 25 and the actual rate is 0, the flow meter displays 25.

If the *Min Flow Limit* is set to -100 and the actual flow is -200, the flow meter displays -100. This can be a problem if the meter's *Min Flow Limit* is set to a value greater than zero because at flows below the *Min Flow Limit*, the flow meter displays zero flow, but the totalizer, which is not affected by the *Min Flow Limit* setting, continues totalizing.

Max Flow Limit

A maximum flow rate setting establishes the filter software settings and the highest rate value to display. Volumetric entries display in the *Rate Units* selected in *Meter > Flow*.

For both unidirectional and bidirectional measurements, set the **Max Flow Limit** to the highest (positive) flow rate expected in the piping system.

Low Flow Limit

A *Low Flow Limit* entry allows the flow meter to display very low flow rates (that can be present when pumps are off and valves are closed) as zero flow. Typical values are 1.0...5.0% of the *Min Flow Limit*.

The *Low Flow Limit* is the minimum flow rate at which the meter gives reliable readings.

Filter Page



Figure 74: Filter settings

Filter Method

The DXN flow meter offers several levels of signal filtering:

- *None* imposes no filtering on the signal from the transducers.
- *Simple with Rejection* uses *Damping* and *Bad Data Rejection* to filter the flow data.
- *Adaptive* filtering allows the meter's software routines to alter the filtering, depending on the variability of the transducer's signal. The *Adaptive* filter uses a combination of *Damping*, *Bad Data Rejection*, *Sensitivity* and *Hysteresis* to modify the flow input data.

Damping (Range 0...100 Seconds)

Damping is the approximate amount of time the filtering routines use to attain a 99% stable rate value. Generally, the higher the damping value, the more stable the rate readings are—but at the expense of response time.

Sensitivity (Range 0...100%)

Sensitivity determines how fast the adaptive filtering responds to a change in rate. Increasing the sensitivity decreases the filtering, which allows the display to respond to rate changes more rapidly.

Hysteresis (Range 0...25%)

Hysteresis creates a window around the average flow measurement reading, defining the limits at which the automatic damping increases occur. If the rate varies within the hysteresis window, greater damping occurs up to the maximum values set by the flow filter *Damping* entry. The filter also establishes a flow rate window where measurements outside of the window are captured by the *Bad Data Rejection* window. Enter the value as a percentage of actual flow rate.

For instance, a *Hysteresis* setting of 5% allows the flow to vary $\pm 5\%$ from the currently established flow rate without automatically decreasing the value of the *Damping*.

For example, if the average flow rate is 100 gpm and the *Hysteresis* is set to 10%, a filter window of 90...110 gpm is established. Successive flow measurements that reside within that window are recorded and averaged in accordance with the *Damping* setting. Flow readings outside of the window are rejected or accepted in accordance with the *Bad Data Rejection* setting.

Filter settings for this example:

Filter Method	Adaptive
Damping	40 seconds
Sensitivity	60%
Hysteresis	10%
Bad Data Rejection	3

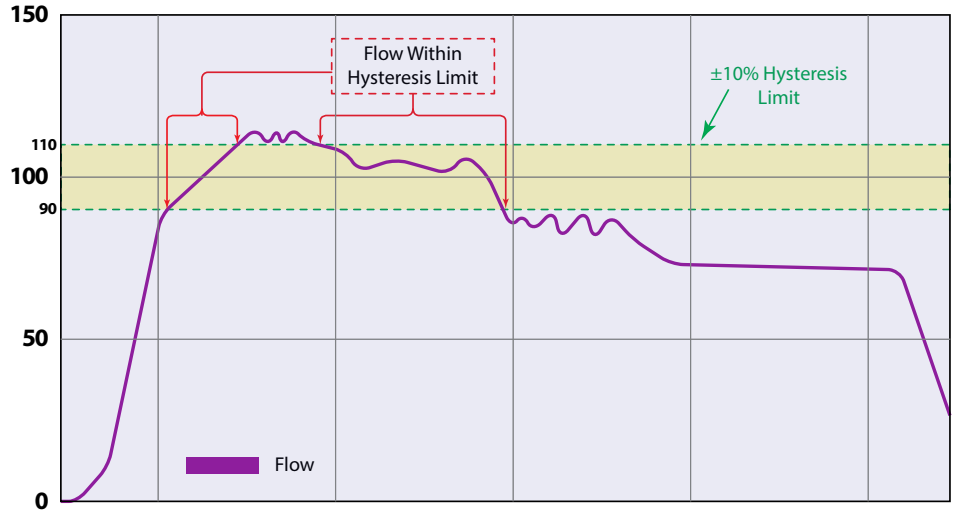

Figure 75: Hysteresis window

Bad Data Rejection (Range 0...10 Samples)

The *Bad Data Rejection* setting is related to the number of successive *readings* that must be measured outside of a the *Hysteresis* value before the flow meter considers the new flow value valid. In this example, a *Hysteresis* setting of 10% produces a $\pm 10\%$ band centered on the current valid flow rate of 100 gpm.

The *Bad Data Rejection* setting is the number of successive *samples* that must be outside of the *Hysteresis* window before the flow meter considers the change in flow as real. Larger values are entered into the *Bad Data Rejection* window when measuring liquids that contain gas bubbles, as the gas bubbles tend to disturb the ultrasonic signals and cause more extraneous flow readings to occur. Larger *Bad Data Rejection* values tend to make the flow meter less responsive to rapid changes in actual flow rate.

In *Figure 77* on *page 59*, flow data falls outside the flow *Hysteresis* window but does not reach the minimum time specified in the *Bad Data Rejection* window. When data appears that is outside the *Hysteresis* band and shorter than the *Bad Data Rejection* window time, the data is rejected.

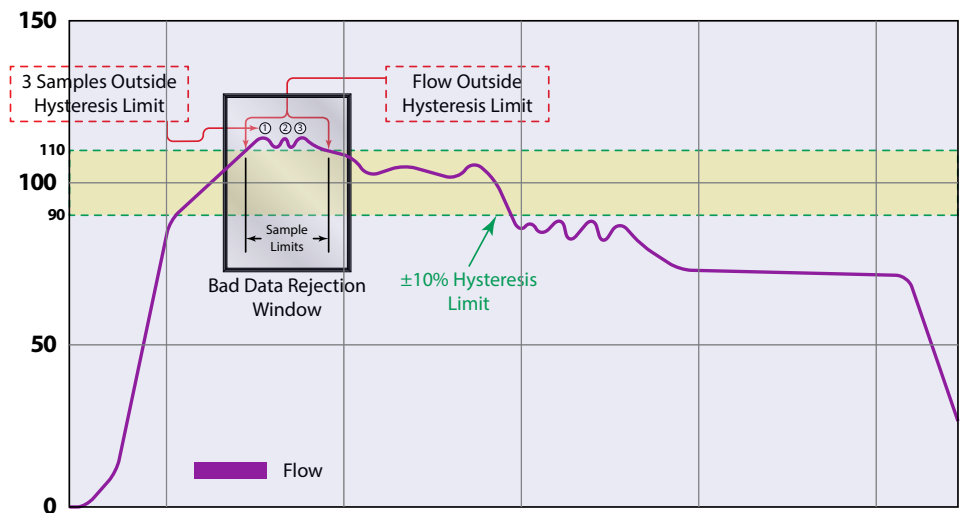

Figure 76: Bad data (rejection)

The flow rate is again outside the original $\pm 10\%$ Hysteresis window, but the data exists for a time period greater than the *Bad Data Rejection* window. In this instance, the meter interprets the data as a new valid flow rate and moves the Hysteresis window to correspond with the new established flow rate.

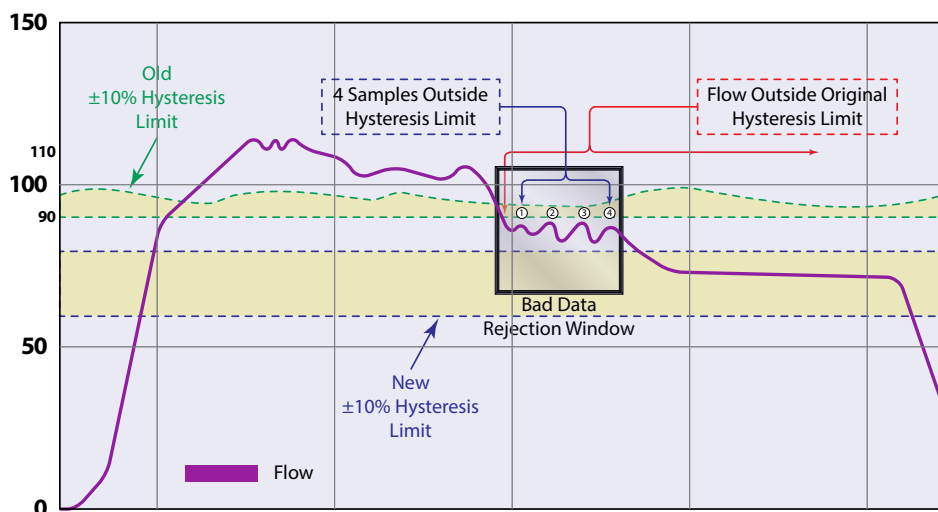

Figure 77: New valid flow data

Energy Page

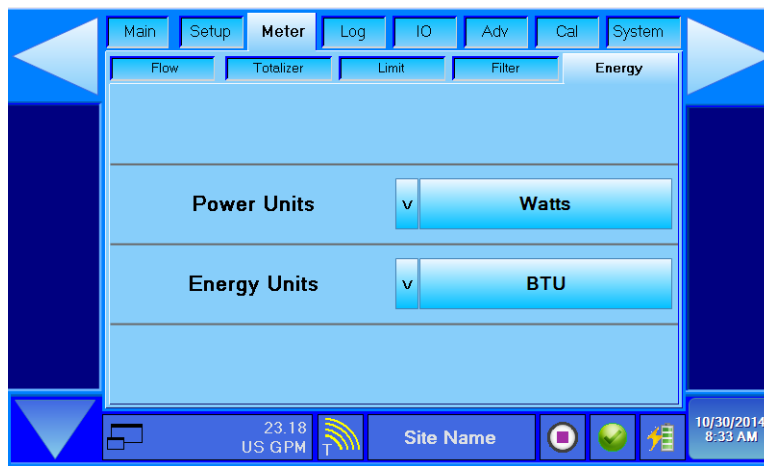

Figure 78: Energy units selection

Power Units

Watts	Btu per hour (Btu/hr)	Thousand Joules per hour (kJ/hr)
Kilowatts (kW)	Thousand Btu per hour (MBtu/hr)	Million Joules per hour (MJ/hr)
Megawatts (MW)	Million Btu per hour (MMBtu/hr)	

Table 15: Power unit choices

Energy Units

British Thermal Units (Btu)	Ton	Thousand Watt Hours (kWh)
Thousands of Btus (MBtu)	Thousand Joules (kJ)	Million Watt Hours (MWh)
Millions of Btus (MMBtu)	Million Joules (MJ)	

Table 16: Energy unit choices

LOG (DATA LOGGING) GROUP



Figure 79: Log Group

Setup Page

The setup screen controls the selection of the Logging Rate and has a software button for starting and stopping logging sessions.

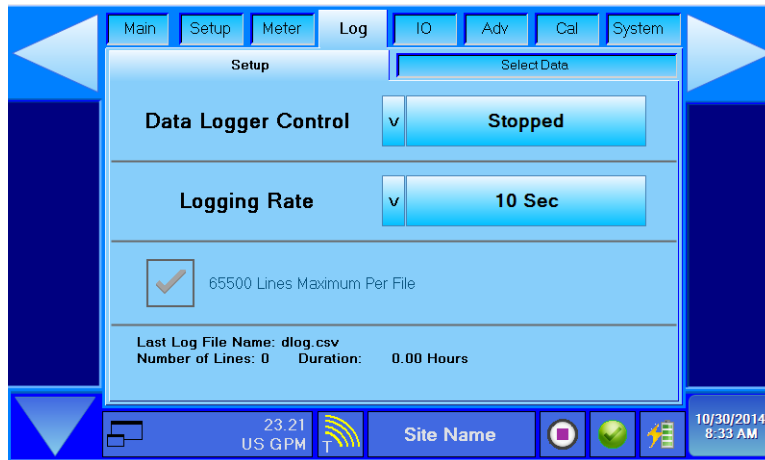

Figure 80: Datalogging setup

Data Logger Control

IMPORTANT

To enable datalogging, a site from the Setup > Site page must be created or selected from previous site names. If a site is not chosen, the datalogger start/stop control button does not function and the control is grayed out.

Logging Rate

The *Logging Rate* entry tells the flow meter how often to collect data points. The logger memory area has the capacity to store more than 300 individual files consisting of a maximum of 65,500 points per log file.

The amount of time the logger collects data depends on the *Logging Rate* programmed into the flow meter. In general, the logging time is calculated by dividing 65,563 by the number of data points recorded per minute.

$$\text{Logging Time (Minutes)} = \frac{65,563}{\text{Number of Samples per Minute}}$$

Logging Rate (Once every #)	Logging Duration			
	Samples/Second	Minutes	Hours	Days
0.1 second (10 Hz)	10	109	1.8	0.08
1 second	1	1092	18.2	0.76
2 seconds	0.5	2183	36.4	1.52
5 seconds	0.2	5458	91.0	3.79
10 seconds	0.1	10,917	182	7.58
20 seconds	0.05	21,833	364	15.2
30 seconds	0.03333	32,750	546	22.7
1 minute	0.01667	65,500	1092	45.5
2 minutes	0.008333	131,000	2183	91.0
5 minutes	0.003333	327,500	5458	227
10 minutes	0.001667	655,000	10,917	455
30 minutes	0.00055556	1,965,000	32,750	1365
1 hour	0.00027778	3,930,000	65,500	2729
2 hours	0.00013889	7,860,000	131,000	5458
4 hours	6.941 ⁻⁵	15,720,000	262,000	10,917
12 hours	2.315 ⁻⁵	47,160,000	786,000	32,750
1 day	1.157 ⁻⁵	94,320,000	1,572,000	65,500

Table 17: Logging durations

Any log files gathered are stored with the site information.

Select Data Page

The *Log > Select Data* lets you choose the way the time is displayed for each logged entry and what kind of data is recorded in the user fields.



Figure 81: Data selection (page 1)

Column 0: Time

Column 0 can be set up for one of three time stamp formats.

- The conventional Year, Month, Day, Hour, Minute, and seconds.
- The Microsoft Excel® decimal time format.
- A simple counter that increments once for each logged entry recorded.

Column 1: Flow

Column 1 always stores the current flow rate in the user-selected units.

Column 2: User, Column 3: User, Column 4: User

The three user-defined fields can be configured to capture any of the following values.

Nothing	Flow	Totalizer Net
Flow Velocity	Reynolds Number	Power
Energy Net	TT Flow	TT Gain
TT Quality	DOP Flow	DOP Gain
DOP Quality	TT Delta T	TT Raw Delta T
TT Fluid SOS	DOP Flow Velocity	DOP Frequency
TT Aperture Start	RTD 1 Temperature	RTD 2 Temperature
RTD Delta Temperature	I/O Voltage In	

Table 18: Logging parameter choices

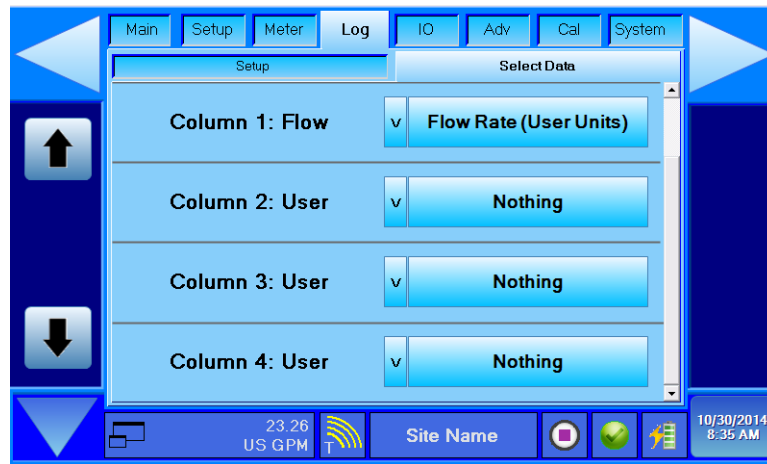

Figure 82: Data selection (page 2)

I/O (INPUT / OUTPUT) GROUP



Figure 83: I/O group

Set Out (Setup Outputs) Page

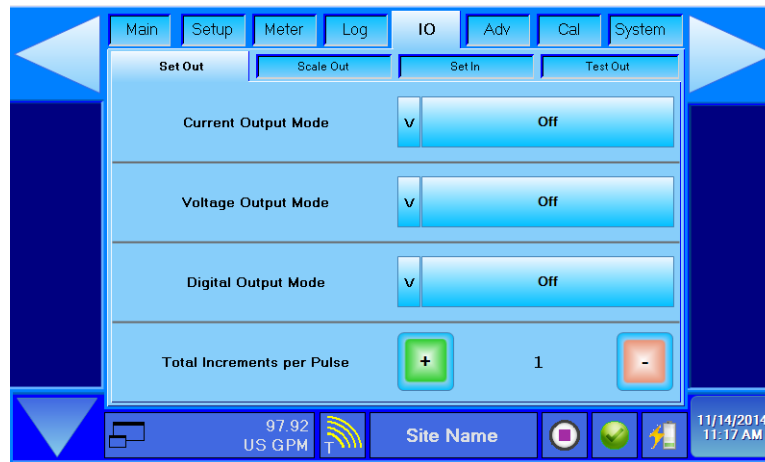

Figure 84: Data outputs setup

The I/O > Set Out option determines which of the flow meter's outputs are active.

- Current Output Mode
- Voltage Output Mode
- Digital Output Mode

The DXN flow meter's output signals are analog or digital/pulse. Analog signals change continuously over time. Digital/pulse signals are present at discrete points and represent information using a sequence of on/off pulses. For connection information, see *Figure 86 on page 64*.

Select the type of I/O from the pull-down lists. The two analog outputs are 4...20 mA and 0...10V DC output. The pulse output has a maximum frequency of 1000 Hz and can be configured as either a rate pulse or a totalizing pulse.

All outputs are scaled the same way using the I/O > Scale Out. For example, 20 mA, 1000 Hz and 0...10V all represent the same maximum flow rate set in the I/O > Scale Out.

Scale Out (Scale Outputs) Page

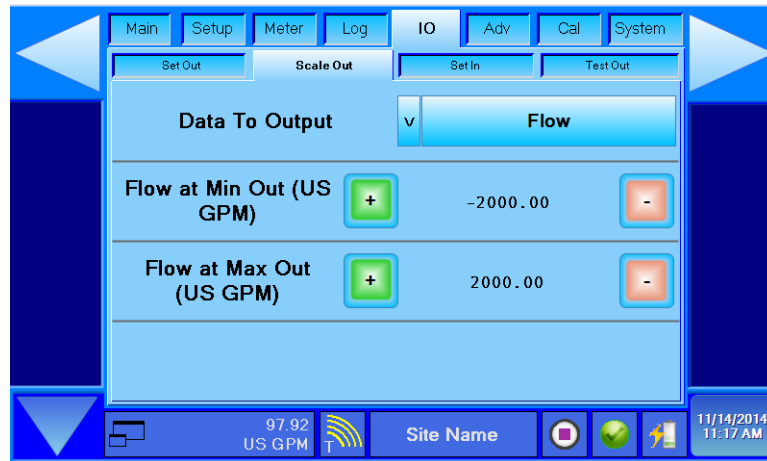

Figure 85: Scale outputs setup

The I/O > Scale Out sets the parameter to which the output circuitry responds.

Data to Output

Choices for *Data To Output* are *Flow* and *Power*.

Flow at Min Out

Flow at Min Out sets the minimum value to which the outputs are scaled.

Flow at Max Out

Flow at Max Out sets the maximum value to which the outputs are scaled.

NOTE: *Transit time* measurements are capable of bidirectional flow but *Doppler* is not. The only time that setting the *Flow at Min Out* to a negative value may be necessary is if the meter stays in *Transit time* mode. If the meter is used in *Doppler* mode exclusively, or when in hybrid mode the meter switches to *Doppler* mode, set the value for *Flow at Min Out* no lower than zero.

An example of a valid use of setting *Flow at Min Out* below zero would be a transit time application where flow can be in either the forward or reverse direction. If, for instance, a tap water system is capable of 100 gpm forward and 100 gpm in reverse, then setting the *Flow at Min Out* to -100 and *Flow at Max Out* to +100 would be valid entries.

If the meter were programmed to output a 4...20 mA signal, then 4 mA would represent -100 gpm and 20 mA would represent +100 gpm. The zero flow point would be indicated as 12 mA (halfway between 4 mA and 20 mA).

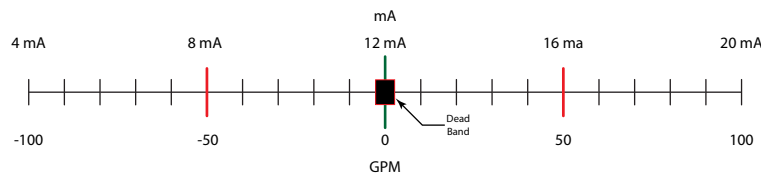

Figure 86: Bidirectional current output

Because no flow meter can read down to zero, there is going to be a small dead band around true zero where the velocity of the fluid is not great enough for the meter to register. The absolute minimum, under perfect conditions, is 0.1 fps (0.03 mps). Whatever flow rates these velocities correspond to create the minimum dead band around true zero.

Set In (Setup Input)

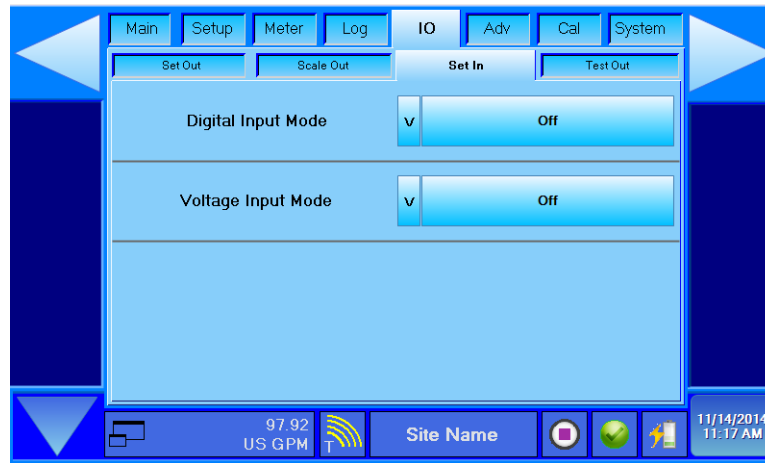

Figure 87: Input setup

Digital Input Mode

- Off: Disables the Digital input
- Reset at 0 Volts: Resets totalizers when the digital input voltage is equal to zero.

Voltage Input Mode

The *Voltage Input* mode contains 3 choices. The *Voltage Input* can be viewed on the *Main > Meters* page or through Modbus communications.

- Off: No voltage input will be read.
- Enable 0-10V Input: Enables the voltage input for a span of 0...10V. Voltage can be scaled in the data log
- Enable 0-5V Input: Enables the voltage input for a span of 0...5V. Voltage can be scaled in the data log

Test Out (Test Outputs) Page

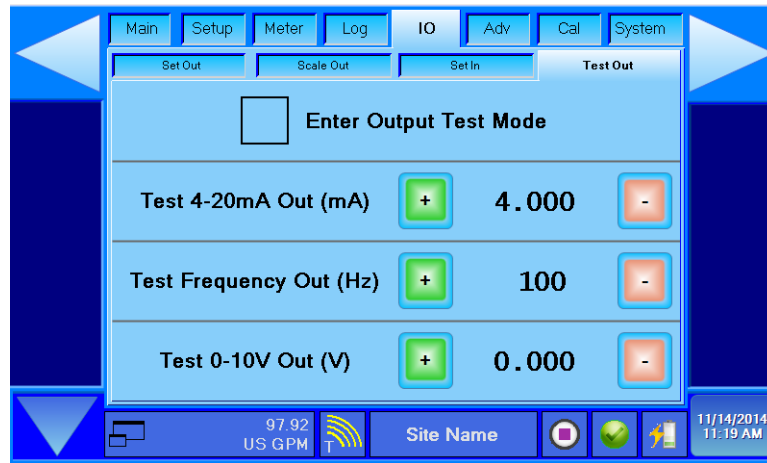

Figure 88: Test outputs setup

The *Test Out* options are used to calibrate devices connected to the flow meter through the I/O breakout box.

To use this function:

1. Connect the output to a device designed to read that type of output signal.
 - For *Test 4...20 mA Out*, use a milliammeter.
 - For *Test Frequency Out*, use either a frequency counter or an oscilloscope.
 - For *Test 0...10V Out*, use a voltmeter.
2. Use the + and – buttons to select the output level to calibrate to. For example, common test levels for the 4...20 mA output are 4, 8, 12, 16 and 20 mA.
3. Put a checkmark in the **Enter Output Test Mode** box to activate the outputs.

ADV (ADVANCED) GROUP

The Advanced group tab provides users a way to troubleshoot problematic applications, as well as setting up the flow meter to best suit application needs. Pages within this tab should only be modified under the guidance of Badger Meter Technical Support or with caution. Modifying values can alter flow measurement accuracy.

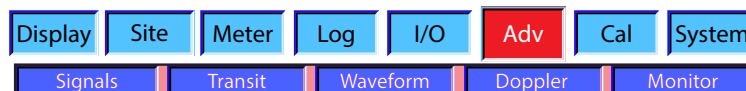

Figure 89: Advanced group

Signals Page

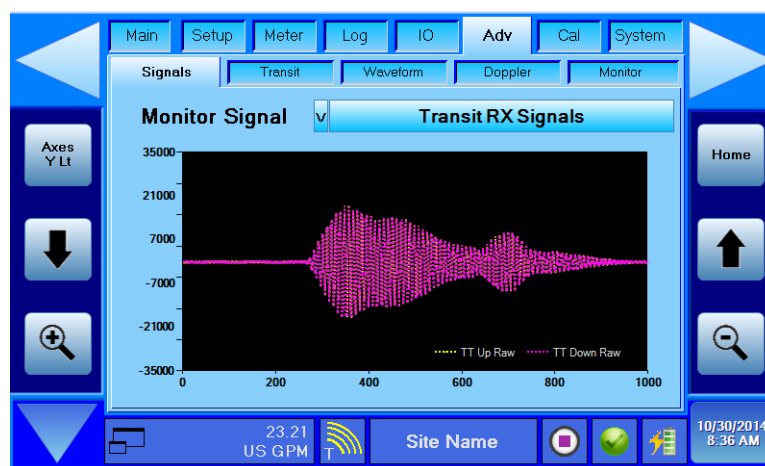

Figure 90: Advanced signals page

Monitor Signal

Select the signal type to be monitored from the *Monitor Signal* pull-down list and adjust the graph scale using the Axes adjustments. This is used for reference only.

Monitor Signal	X axis	Description
Transit RX Signals	0...1000	Received Up/Down Signals
Transit RX Signals Analyzed	0...1000	Received Up/Down Signals, Analysis Portion
Transit RX Noise	0...1000	Received Up/Down Noise test signals
Transit XCorr	-40...40	Cross Correlations
Transit XCorr Alt	-40...40	Alternate Cross Correlations
Transit RX Envelope	0...1000	Received Up/Down signal Envelopes
Transit Rx Alt	0...1000	Alternate Received Up/Down Signals
Transit RX Waveout	0...1000	Transmitted Up/Down Waveforms
Pipe Thickness Signals	0...1000	Pipe Thickness Test Signals
Doppler Best Acorr	0...50	Doppler Autocorrelations
Doppler Best Rate	0...200	Doppler Auto Sample Rate Raw Data
Doppler Full Rate	0...200	Doppler 25 kHz Sample Rate Raw Data
Doppler HI Rate	0...200	Doppler 25/4 kHz Sample Rate Decimated
Doppler MED Rate	0...200	Doppler 25/16 kHz Sample Rate Decimated
Doppler LO Rate	0...200	Doppler 25/32 kHz Sample Rate Decimated

Table 19: Monitor signal parameters

Axes Scaling Buttons

Press the **Axes** button successively to move through the three axis configuration choices, as shown in *Figure 91*.

The X axis is always time based. Press **+** **magnifying glass** or **- magnifying glass** to expand or contract the timeline shown on the horizontal (X axis). The minimum graph time period is 10 seconds and the maximum is 1 year.

The *Axis Y Lt* and *Axis Y Rt* functions control the scale of the left and right sides of the graphs Y axis, respectively.

The *+ magnifying glass* and *- magnifying glass* work in the same fashion as on the X axis except that on the *Axis Y Lt* and *Axis Y Rt* they expand or contract the range of the vertical scaling.

The *Up Arrow* and *Down Arrow* buttons shift the zero point of the graph up or down.

The *Home* button resets the graph to the parameters set on the *Main > Graph Setup* screen.

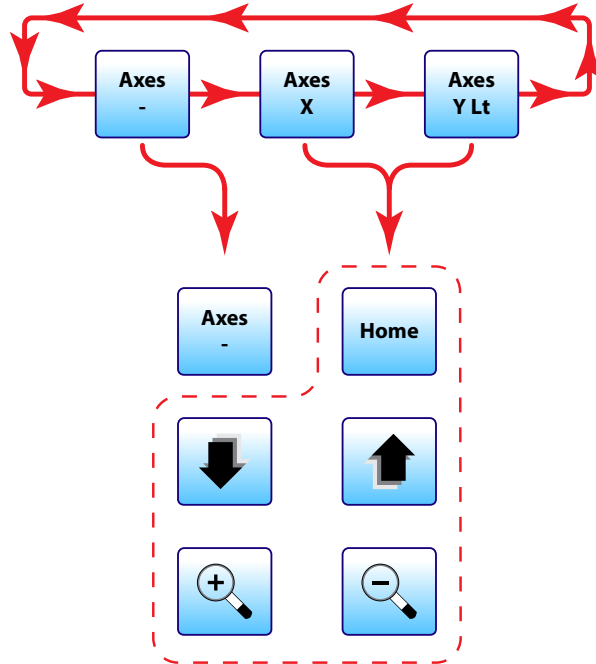

Figure 91: Graph axis configuration

Transit Page

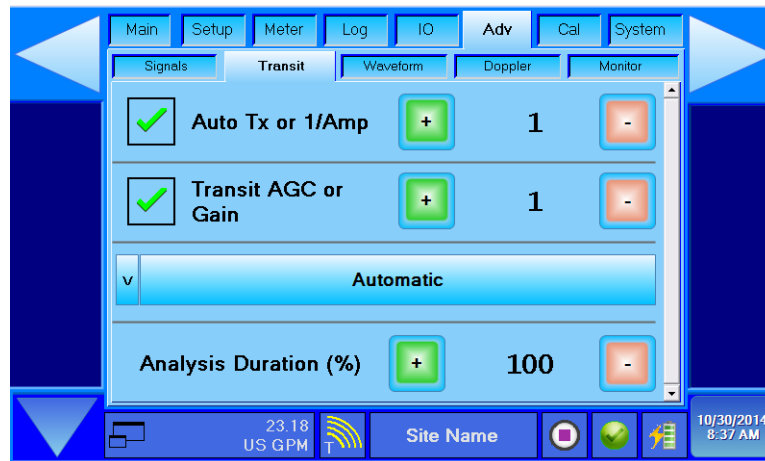

Figure 92: Advanced transit time setup

Auto Tx or 1/Amp

- Transmit attenuation.
- When box is checked, attenuation is automatic).
- When box is unchecked, attenuation is manual. 1...16 time attenuation. If 16, then transmitted signal is 1/16th full power.

Transit AGC or Gain

- Automatic Gain Control override.
- Box is checked means gain is automatic.
- Box is unchecked means manual gain control. Setting is 1...100%, 100% is largest gain, 1% is smallest gain.

Automatic Pull-Down List

This controls the analysis of the transit time data used to determine flow.

- Automatic
- Harmonic EnvPH – An analysis that is best suited for sine wave type output waveforms (Sin, Sine Carrot Top). Uses correlation to detect peak hop (use Sine Carrot Top).
- Harmonic NoPH – An analysis that is best suited for sine wave type output waveforms (Sin, Sine Carrot Top). No peak hop detection is implemented, for slow flows only.
- Correlation MaxPH – Uses correlation analysis, which correlates signal envelopes for peak hop detection.
- Correlation EnvPH – Uses correlation analysis, which uses maximum of raw signal correlation for peak hop detection. Very useful for high speed flows, especially if waveform is set to Best Barker, Chirp or Sin Carrot Top.
- Correlation NoPH – Uses correlation analysis, which uses peak within first wavelength for flow rate. Cannot fail to give a result.

Analysis Duration (%)

Override of automatic analysis duration control.

Only a portion of the signals seen in the RX window is used.

- 10% means 10% of the automatic value.
- 100% means 10 times the automatic value. This is limited to the full number of samples collected.

Waveform Page



Figure 93: Advanced waveform selection

For most applications, select the **Automatic** waveform. In some circumstances, you may select an alternate waveform at the direction of Badger Meter Technical Support.

Automatic Pull-Down List Options

This controls the transmitted waveform. This is very useful for various flow conditions.

- Automatic
- Sin - Straight sine wave. Frequency can be adjusted.
- Sin Carrot Top - Sine wave with Triangular envelope (50%). Frequency can be adjusted.
- Chirp - Frequency swept sin wave. Frequency & bandwidth can be adjusted.
- Best Barker - 3, 5, 7, 11 or 13 chips. Chips & Wavelengths per chip are determined with transducer and setup. Frequency can be adjusted. Chip count is adjusted automatically to Duration.

Best Barker is best for high speed flows.

Sin Carrot Top is best for low speed flows.

Waveform Duration (%)

Overrides of automatic transmit duration control. This can be useful for high speed flows.

Transmitted waveform duration is automatically calculated based on pipe setup transducers, etc.

- 1% means 1% of the automatic value.
- 100% means 1x times of the automatic value.

For a high speed flow, users can try 75%, 50%, and even 25% durations depending on transducer types and setups.

Nominal Frequency (%) and Secondary or Width (%)

These two adjustments are really only useful if Waveform is not automatic.

- Frequency is adjustable from 50% to 200% nominal.
- Secondary or Width is from 50% to 200% nominal. This is seldom used (only for Chirp).

Doppler Page

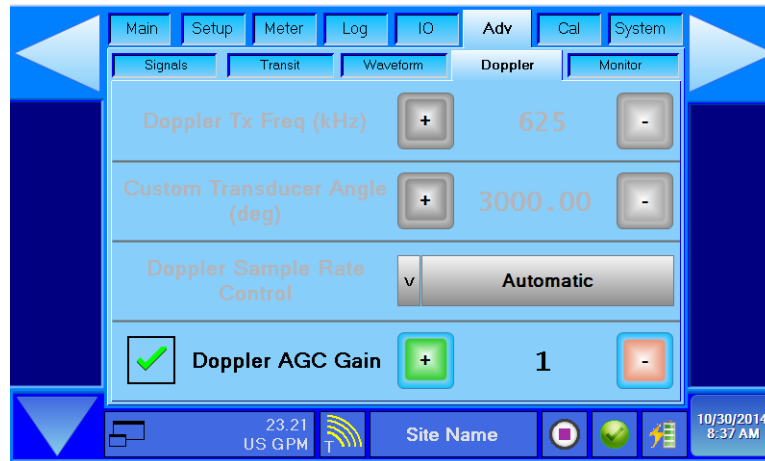

Figure 94: Advanced Doppler setup

Doppler Tx Freq (kHz)

Read only. Doppler baseband frequency (usually 625 kHz).

Custom Transducer Angle (deg)

Read only. Doppler Transducer Launch Angle (30.00°).

Doppler Sample Rate Control

Read only. Doppler sample rate control is automatic.

Doppler AGC Gain

Overrides Doppler Automatic Gain control:

- When the box is checked, gain control is automatic.
- When the box is unchecked, gain control is manual. 1...100% of full scale. 1 means 1% full scale.

Monitor Page



Figure 95: Advanced monitor

Waveform Update Rate (s)

Read only. Waveform update rate. Default is 1 update per 5 seconds only when waveform tab is visible.

Snapshot Rate (s)

Read only. Data snapshot rate. Default is 1 update per 1 second.

System Info Rate (s)

Read only. Power System & OS information rate. Default is 1 update per 10 seconds.

CAL (CALIBRATION) GROUP



Figure 96: Calibration group

Transit Page



Figure 97: Calibrate transit time

Delta Time Zero (ns)

Press **Delta Time Zero (ns)** zeros to remove the No Flow transit time offset. This is also referred to as Zeroing the meter. Because every flow meter installation is slightly different and sound waves can travel in slightly different ways through these various installations, it is important to remove the zero offset at zero flow to maintain the meter's accuracy. To establish Zero flow and eliminate the offset:

1. The pipe must be full of liquid.
2. Flow must be absolutely zero. Securely close any valves and allow time for any settling to occur.
3. Press **Delta Time Zero (ns)** once.

User Adjustment

This allows the user to enter a calibration factor. The range can be 0.2...5.0. This adjustment modifies the indicated flow rate by multiplying the flow rate value by the number entered into the *User Adjustment* field. For example, if indicated flow rate is 20 gpm, a user adjustment of "2.000" will modify the flow rate to 40 gpm.

NOTE: Only use this under the guidance of Badger Meter Technical Support. Default should always be "1.000".

Positive Flow

As of Rev K, the Positive flow checkbox is always marked. This checkbox will be used to allow reversal of measurement.

Reynolds Correcting

As of Rev K, the Reynolds Correcting checkbox is always greyed and unmarked.

This checkbox will be used to allow Reynolds compensation of flow measurements. Currently, the DXN does not support Reynolds compensation.

SOS Comp

When *SOS Comp* is not checked, the flowmeter equation simply uses the soundspeed from the lookup table as:

$$C_{fluid} = C_{fluid \text{ from lookup table}}$$

When *SOS Comp* is checked, the flowmeter equation uses the soundspeed as measured from the signals:

$$C_{fluid} = \frac{L_{fluid}}{t_{fluid}}$$

Where L is the fluid length where the ultrasound travels, and:

$$t_{fluid} = t_{signal} - 2 * (t_{piezo} + t_{resdelay} + t_{transducer} + t_{pipe} + t_{liner})$$

$$t_{signal} = t_{peak} + t_{aperture \ start} - t_{signaloffset} - t_{daq} - t_{waveform} - t_{electronics}$$

The following are constants for the hardware:

- Electronics circuits: t_{daq}
 $t_{electronics}$
- Transducers: t_{piezo}
 $t_{resdelay}$
 $t_{transducer}$
- Setup: t_{pipe}
 t_{pipe}
 $t_{waveform}$
- Cal->Transit-> SOS Offset: $t_{signaloffset}$

Soundspeed Offset Button and Numeric Control

This button figures out $t_{signaloffset}$ such that $C_{fluid} = C_{fluid \text{ from lookup table}}$

NOTE: The *Soundspeed Offset* is only useful when *SOS Comp* is checked.

Doppler Page

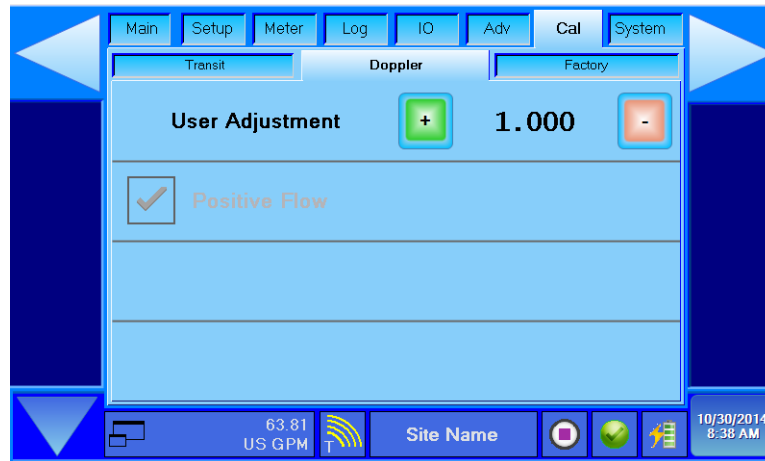

Figure 98: Calibrate doppler

User Adjustment

This allows the user to enter a calibration factor. The range can be 0.2...5.0. This adjustment modifies the indicated flow rate by multiplying the flow rate value by the number entered into the User Adjustment field. For example, if indicated flow rate is 20 gpm, a user adjustment of "2.000" will modify the flow rate to 40 gpm.

NOTE: Only use this under the guidance of Badger Meter Technical Support. Default should always be "1.000".

Positive Flow

This is always grayed and checked. Doppler flow is always positive for our instruments as of 2014.

Factory Page

The factory calibration page shows all the parameters stored in the flow meter's memory, originally derived during calibration. These are the values that re-load when you use press **Load Default Settings** from *Setup > Site*.



Figure 99: Factory calibration (page 1)

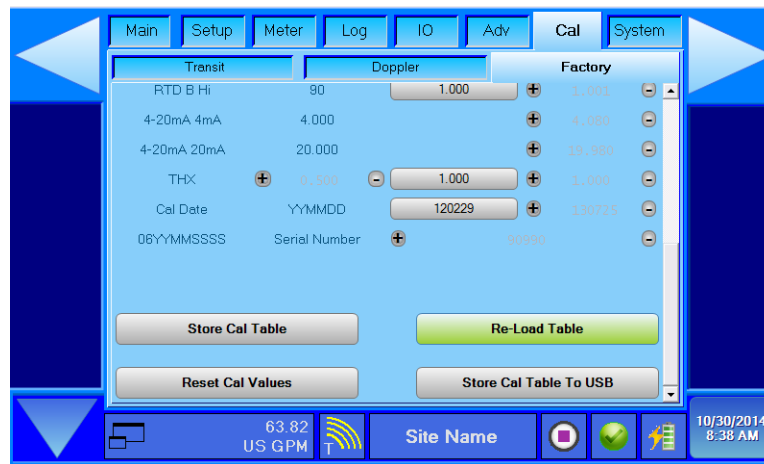

Figure 100: Factory calibration (page 2)

Store Cal Table

For factory use only.

Reset Cal Values

For factory use only.

Re-Load Table

For factory use only.

Store Cal Table to USB

For factory use only.

SYSTEM GROUP

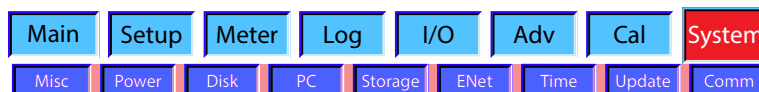

Figure 101: System group

Misc (Miscellaneous) Page

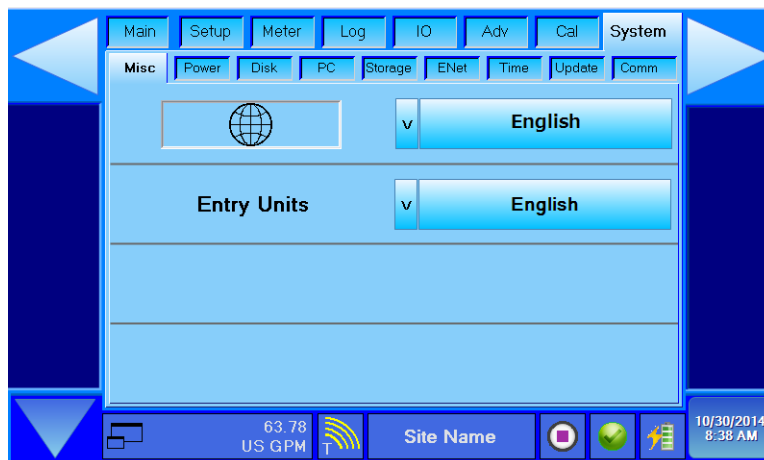

Figure 102: System miscellaneous

Language

Use the *Language* pull-down list to select the language for screen displays.

English	Deutsch	Français
Español	Japanese	Русский
Português	Italiano	Netherlands
Svenska	Norsk	

Table 20: Language selections

Entry Units

Entry Units are the units of measurement for configuring meters.

Select **English** for inches or **Metric** for millimeters.

NOTE: The *Entry Units* are independent of the choices made to display flow rate, total, energy readings and similar units. For example, the meter can be configured for a 2" ANSI pipe and still have the rate displayed in liters per minute (lpm).

The *English/Metric* selection also configures the DXN flow meter to display sound speeds in pipe materials and liquids as either feet per second (fps) or meters per second (mps), respectively.

IMPORTANT

If the Entry Units choice has been changed from English to Metric or from Metric to English, the entry must be saved by doing a power down and then a power up in order for the DXN flow meter to initiate the change in operating units. Failure to save and reset the flow meter results in improper transducer-spacing calculations and an instrument that may not measure properly.

Power Page

The *System > Power* page has a group of lights that indicate the state of the internal Lithium-Ion battery.

The flow meter has a sophisticated battery management circuit that provides a long trouble-free battery life. The meter can remain connected to the charger without over-charging the battery.

The page consists of four status indicator lights and a graph that shows the charge percentage and the battery temperature. The first two lights are battery status lights and the last two indicate if the charger is connected and how many charging cycles the battery has been through.

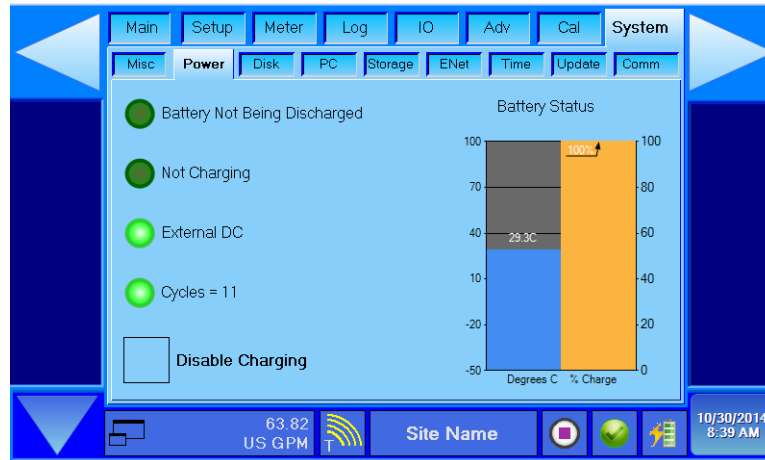

Figure 103: System Power

The first light stays lit as long as there is enough power remaining in the battery to run the meter. When the meter is connected to the battery charger, the text to the right of the light says “Battery Not Being Discharged”. When the charger is removed, the text changes to show the estimated running time before the battery becomes fully discharged. A typical status message would be “6.5 Hours Battery Runtime”.

- The battery life indicator is continuously being updated. If the current draw from the battery increases—as when the outputs are switched on—the runtime indicator recalculates the battery life.
- The second light reports on the battery’s charging status, either “Charging” or “Not Charging.” The battery only charges when there is a need and the charger is connected. The fact that the charger is connected does not necessarily mean that the battery is charging.
- The third light indicates whether the charger is connected. When the External DC light is on, the charger is connected and powering the meter. The charger may or may not also be charging the battery, depending on the battery status.
- The fourth light is the *Cycle* counter and indicates the number of charging cycles the battery has undergone.
- Check the **Disable Charging** box when the meter is going to run on AC power for a long time. The *Disable Charging* feature prevents the battery from generating excessive heat. In some cases, a lower level of noise is realized.

The graphs to the right of the battery status indicator show the present temperature of the battery and the percentage of charge the battery currently holds.

Auto Shutdown

The meter has a feature to help prevent the flow meter from operating in a low battery range. Any time the flow meter battery goes below 5% charge, the user is prompted to plug in the charger. The meter will automatically shut down if the charger is not plugged in within 120 seconds.

Disk Page

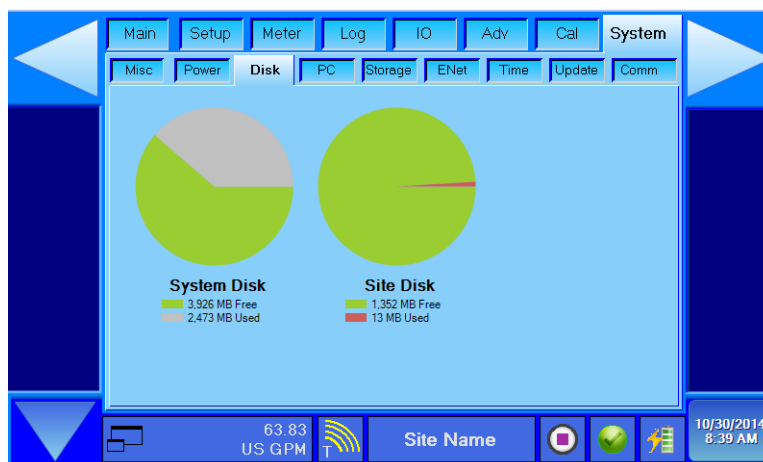

Figure 104: System disk

The *System > Disk* page provides information about the meter's hard disk storage capacity. The flow meter uses an 8 gigabyte hard drive, of which, 1 gigabyte is available to the user.

PC Page

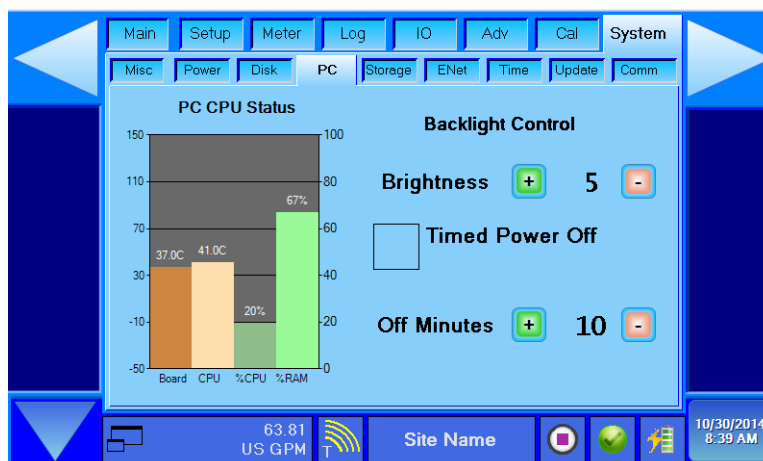

Figure 105: System PC

PC CPU STATUS

The status graph shows the temperature of the system processor board and the CPU (Central Processing Unit), the percentages of RAM (Random Access Memory) used and how busy the CPU is.

Backlight Control

The *System > PC* page contains the backlight brightness control and the switch for the automatic screen saver. Judicious use of these controls help extend the battery life between charges. The flow meter's WVGA screen consumes about 1/3 of the battery capacity when the meter is running on battery. By using the screen saver and lowering the amount of backlight when conditions permit, battery life is significantly extended for that session.

- The backlight *Brightness* control ranges from a low of 1 (least bright) to 5 (brightest).
- The *Timed Power Off* box, when checked, enables the screen saver to start after the time indicated in *Off Minutes*. Tap the display to turn it back on..
- The *Off Minutes* has a range of 0...50 minutes.

If the meter is running with the battery charger connected, there is no need to either decrease the backlight or use the screen saver function.

Storage Page



Figure 106: System storage

The *System > Storage* page helps you manage the sites stored in the flow meter's memory.

To manage a site:

Use the **Select Site to Manage** pull-down list to choose the site to be modified or deleted. Once the site is selected several actions become available.

Copy Site To USB

Copies all of the files associated with the selected site to a USB device connected to the USB port on the meter.

Rename Site

Lets you change the site name.

Delete Site Logs

To delete the site logs:

1. Place a checkmark in the **Unlock Logs Delete** box. The *Delete Site Logs* button turns red.
2. Press **Delete Site Logs** to delete all the logs for the site chosen in the *Select Site To Manage* control.

Delete Site

The *Delete Site* control deletes both the site logs and the site itself:

1. Place a checkmark in the **Unlock Site Delete** box. The *Delete Site* button turns red to warn that the entire site is about to be deleted.
2. Press **Delete Site** to delete the site and the site logs from the meter's memory space.

ENet Page

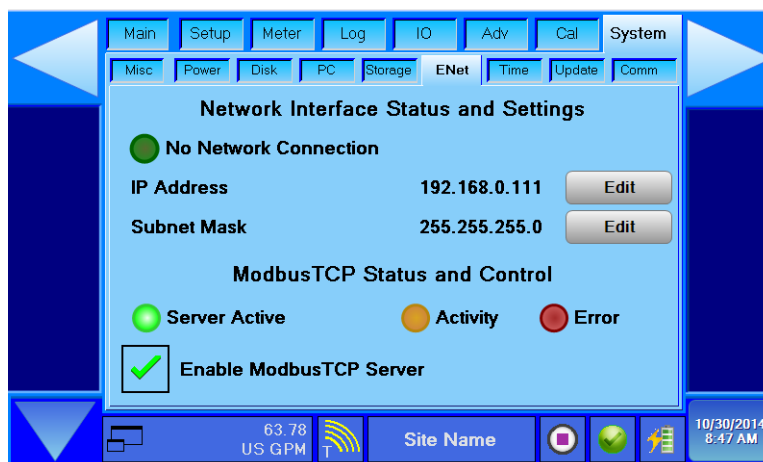

Figure 107: System ethernet (ENet)

The *ENet* page shows the status of the network interface settings and the Modbus TCP connection, as well as controls for each.

Network Interface Status and Settings

- The *No Network Connection* light indicates the network connection is lost.
- Use the *IP Address* **Edit** option to change the address.
- Use the *Subnet Mask* **Edit** option to change the mask.

Modbus TCP Status and Control

- The *Server Active* light indicates the Modbus TCP Server is connected.
- The *Activity* light indicates legitimate Modbus TCP requests.
- The *Error* light indicates a Modbus request error.
- Check the **Enable Modbus TCP Server** box to activate the ability to connect via Modbus.

Modbus TCP Connection Instructions

	Bits	Bytes	Modbus Registers
Long Integer	32	4	2
Single Precision IEEE754	32	4	2
Double Precision IEEE754	64	8	4

Table 21: Modbus data formats

Modbus Register / Word Ordering

Each Modbus Holding Register represents a 16-bit integer value (2 bytes). The official Modbus standard defines Modbus as a 'big-endian' protocol where the most significant byte of a 16-bit value is sent before the least significant byte. For example, the 16-bit hex value of '1234' is transferred as '12'34'.

Beyond 16-bit values, the protocol itself does not specify how 32-bit (or larger) numbers that span over multiple registers should be handled. It is very common to transfer 32-bit values as pairs of two consecutive 16-bit registers in little-endian word order. For example, the 32-bit hex value of '12345678' is transferred as '56'78'12'34'. Notice the Register Bytes are still sent in big-endian order per the Modbus protocol, but the Registers are sent in little-endian order.

Other manufacturers store and transfer the Modbus Registers in big-endian word order. For example, the 32-bit hex value of '12345678' is transferred as '12'34'56'78'. It does not matter in which order the words are sent, as long as the receiving device knows which way to expect it.

Since it is a common problem between devices regarding word order, many Modbus master devices have a configuration setting for interpreting data (over multiple registers) as 'little-endian' or 'big-endian' word order. This is also referred to as swapped or word-swapped values and allows the master device to work with slave devices from different manufacturers.

If, however, the endianness is not a configurable option within the Modbus master device, it is important to make sure it matches the slave endianness for proper data interpretation. The transmitter actually provides two Modbus Register maps to accommodate both formats. This is useful in applications where the Modbus Master cannot be configured for endianness.

Operation

ModbusTCP allows users the ability to monitor basic parameters such as flow and totals via the Ethernet port. The DXN ModbusTCP operation is automatic, and starts up automatically. Errors may be cleared with some settings changes and disabling/enabling Modbus TCP server. During setup, system error boxes may pop up indicating network conflicts.

- *Server Active* indicator is bright green when operating properly.
- *Network Connected* is bright green when network is connected properly.
- *No Network Connection* will appear with a dull green box if there is no Ethernet connection.
- *Activity* will flash upon successful read of Modbus Registers.
- *Error* will flash upon improper reads/writes, or incorrect Modbus addressing.

First, set up the Ethernet settings that will be used to monitor the flow meter:

1. Make sure to unplug the Ethernet cable.
2. Navigate to *System > ENet*.
3. Verify the *Enable Modbus TCP Server* box is unchecked. If checked, press the box to disable the Modbus TCP server.

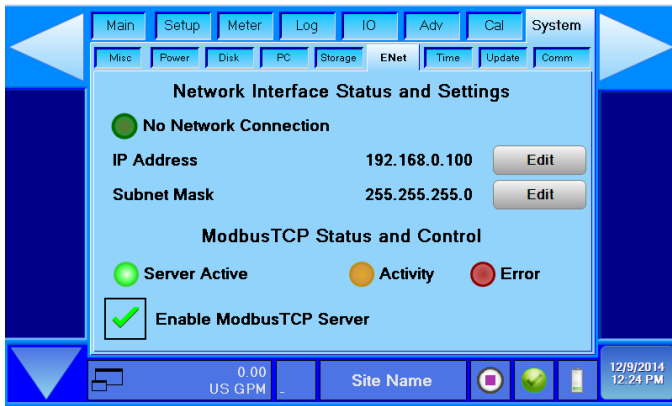

Figure 108: Modbus TCP server enabled

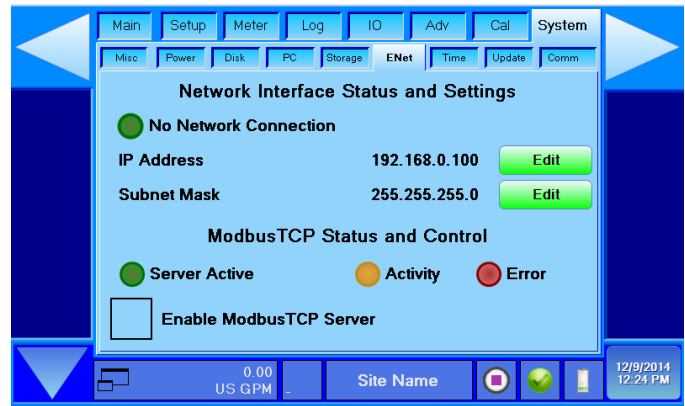

Figure 109: Modbus TCP server disabled

4. Press **Edit** to change IP Address or Subnet Mask to the desired setting for the network.

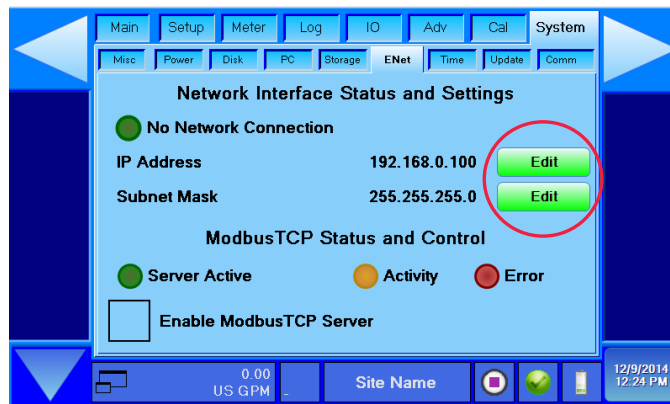

Figure 110: Edit buttons

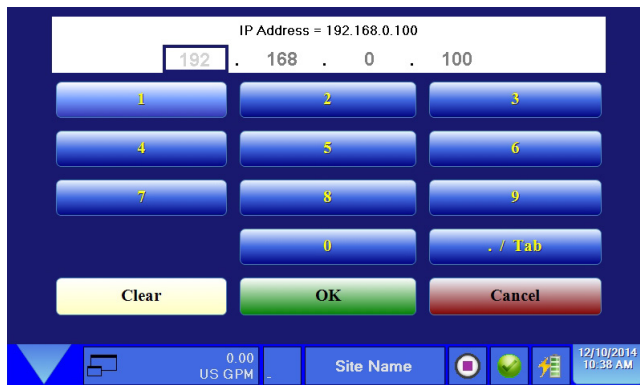

Figure 111: IP address edited

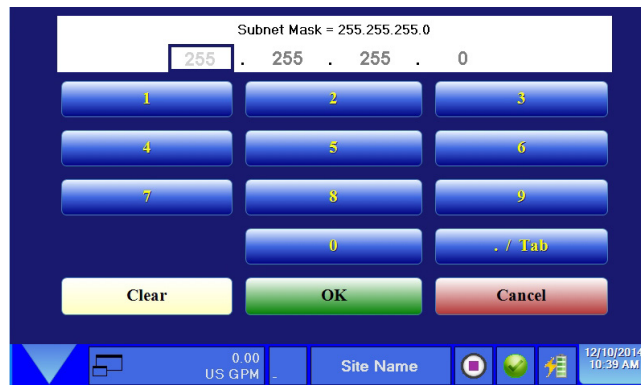

Figure 112: Subnet mask edited

5. When changes are finished, check the **Enable ModbusTCP Server** box to enable Modbus TCP server.
6. Reconnect the Ethernet cable and verify communications.

Modbus Register Addresses

Data Component Name	MODBUS Registers			Available Units
	Long Integer Format	Floating Point		
		Single Precision Format	Double Precision Format	
Signal Strength	40100 - 40101	40200 - 40201	40300 - 40303	Gallons, Liters, MGallons, Cubic Feet, Cubic Meters, Acre Feet, Oil Barrel, Liquid Barrel, Feet, Meters, Lb, Kg, BTU, MBTU, MMBTU, TON, kJ, kW, MW Per Second, Minute, Hour, Day
Flow Rate	40102 - 40103	40202 - 40203	40304 - 40307	
Net Totalizer	40104 - 40105	40204 - 40205	40308 - 40311	
Positive Totalizer	40106 - 40107	40206 - 40207	40312 - 40315	
Negative Totalizer	40108 - 40109	40208 - 40209	40316 - 40319	°C
Temperature 1	40110 - 40111	40210 - 40211	40320 - 40323	
Temperature 2	40112 - 40113	40212 - 40213	40324 - 40327	°C

Table 22: Flow meter modbus register map for 'little-endian' word order master devices

For reference: If the flow meters Net Totalizer = 12345678 hex
 Register 40102 would contain 5678 hex (Word Low)
 Register 40103 would contain 1234 hex (Word High)

Data Component Name	MODBUS Registers			Available Units
	Long Integer Format	Floating Point		
		Single Precision Format	Double Precision Format	
Signal Strength	40600 - 40601	40700 - 40701	40800 - 40803	Gallons, Liters, MGallons, Cubic Feet, Cubic Meters, Acre Feet, Oil Barrel, Liquid Barrel, Feet, Meters, Lb, Kg, BTU, MBTU, MMBTU, TON, kJ, kW, MW Per Second, Minute, Hour, Day
Flow Rate	40602 - 40603	40702 - 40703	40804 - 40807	
Net Totalizer	40604 - 40605	40704 - 40705	40808 - 40811	
Positive Totalizer	40606 - 40607	40706 - 40707	40812 - 40815	
Negative Totalizer	40608 - 40609	40708 - 40709	40816 - 40819	°C
Temperature 1	40610 - 40611	40710 - 40711	40820 - 40823	
Temperature 2	40612 - 40613	40712 - 40713	40824 - 40827	°C

Table 23: Flow meter modbus register map for 'big-endian' word order master devices

For reference: If the flow meters Net Totalizer = 12345678 hex
 Register 40602 would contain 1234 hex (Word High)
 Register 40603 would contain 5678 hex (Word Low)

Modbus Coil Description	Modbus Coil	Notes
Reset Totalizers	1	Forcing this coil on will reset all totalizers. After reset, the coil automatically returns to the off state.

Table 24: Modbus coil map

Time Page

The *System > Time* page provides date and time setting controls. The current date is shown on a calendar page with the currently programmed date highlighted in blue.

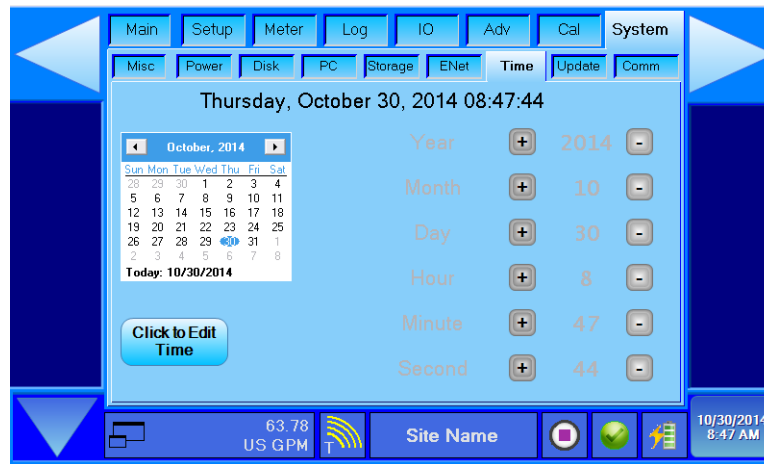

Figure 113: System time

1. To access the date/time controls, press **Press to Edit Time**. All the date/time controls on the right side of the screen become active and the button changes to "Press to Set Time".
2. Use the Increment and Decrement buttons to set the correct date and time.
3. Press **Press to Set Time** to load the settings into the system memory.

Update Page

The *System > Update* page is used in conjunction with software updates supplied by Badger Meter to install new software revisions into the DXN system. For complete updating instructions, see "Upgrading Software" on page 91.

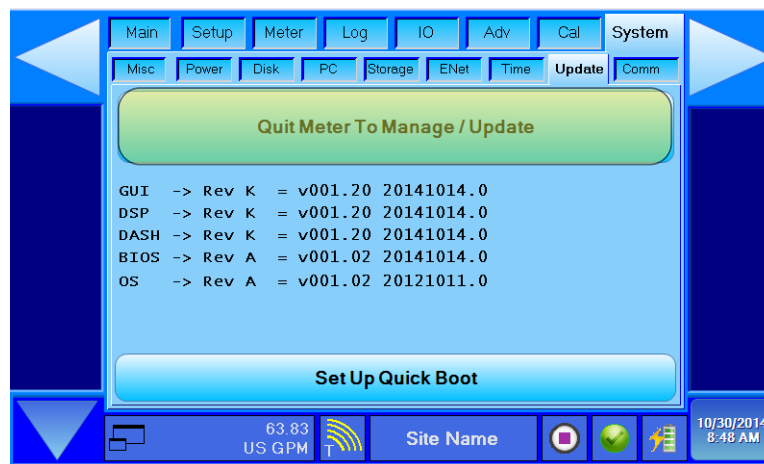

Figure 114: System update

Quit Meter to Manage / Update

Press this option to open the main splash screen where you can enter or configure the flow meter, software updates and system settings.

Set Up Quick Boot

Press this option to set up the flow meter to boot faster. After first time use, some bootup menus become unnecessary. Enabling this skips those menus.

Comm (Communications) Page

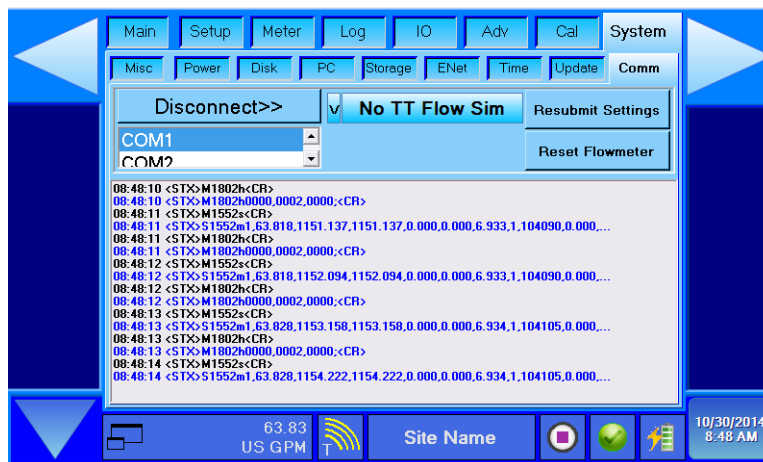

Figure 115: System communications (comm)

The *Comm* page is mostly for engineering and debugging purposes.

The scrolling blue and black text indicates proper communication.

Disconnect Pull-Down Menu

Use this selection to connect or disconnect communication to the flow meter.

No TT Flow Sim

Indicates the status of flow simulation.

Resubmit Settings

Resubmits the current flow meter settings.

Reset Flow Meter

Electronically resets the flow meter, then resubmits the settings.

INPUTS/OUTPUTS

General

The DXN system offers a variety of input and output options. The individual I/O connections are accessed by using the included Breakout Box connected to the flow meter via a DB15 cable connection labeled *Process I/O*.

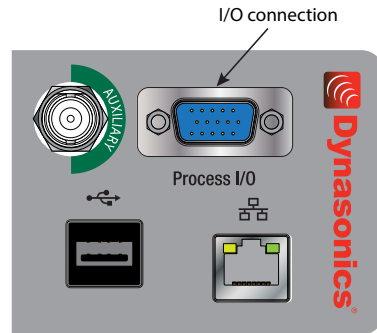

Figure 116: Display I/O connection

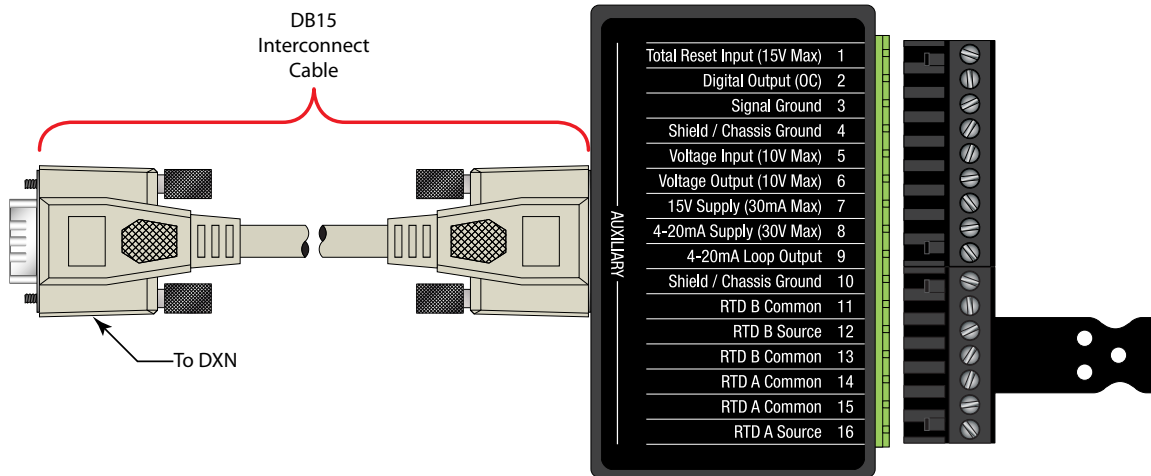
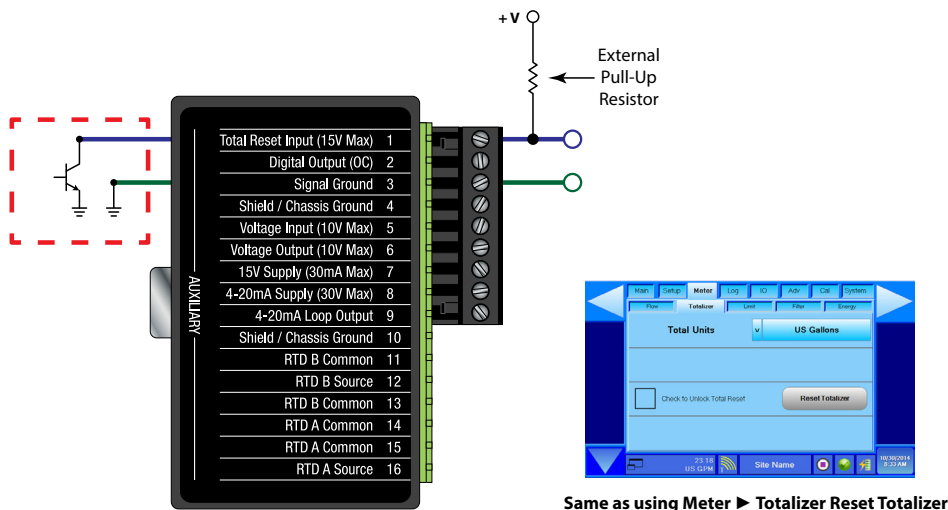

Figure 117: Breakout box

Total Reset



Same as using Meter ► Totalizer Reset Totalizer

Figure 118: External totalizer reset

Digital Outputs

Digital/Pulse Outputs

The digital output is an open collector transistor which must have a pull-up resistor to function. The output can be configured as either a frequency output scale, based upon the minimum and maximum flow rate chosen, or a totalizing pulse controlled by the incrementing totalizer.

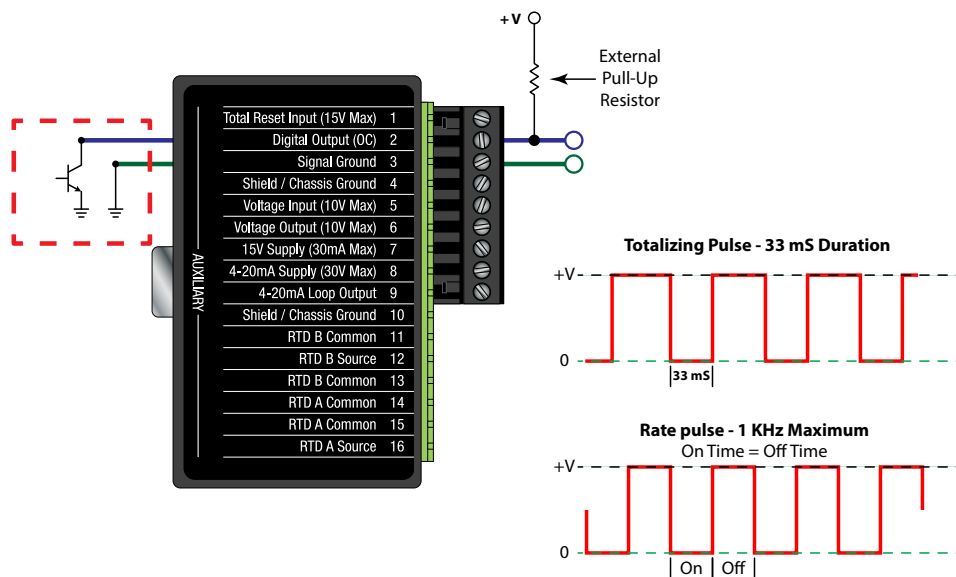

Figure 119: Digital output external power

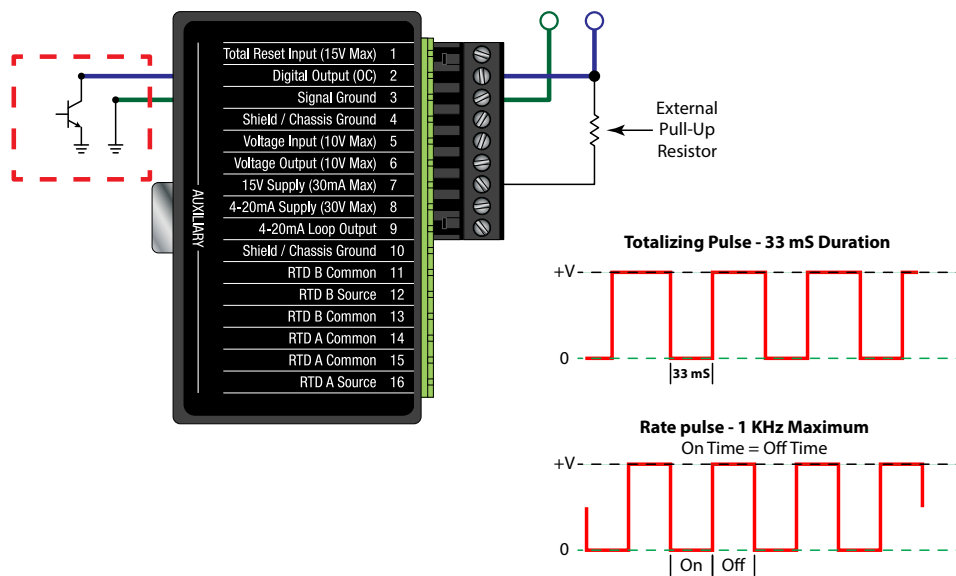

Figure 120: Digital output internal power

Rate Pulse Scaling

The rate pulse has a maximum frequency of 1000 Hz that is proportional to the minimum and maximum user flow rates entered. Setting the minimum and maximum flow rates is accomplished using the *Meter > Limit* software controls.

For example, if the minimum flow rate were set to -100 gpm and the maximum flow rate was +100 gpm the 1000 Hz output would span the distance from -100...100 gpm.

In this example the output frequency would then be interpreted as follows:

0 Hz	=	-100 gpm
250 Hz	=	-50 gpm
500 Hz	=	0 gpm
750 Hz	=	+50 gpm
1000 Hz	=	+100 gpm

The maximum current capacity for the transistor is 100 mA with a maximum supply voltage of 10V DC. These parameters require the pull-up resistor rated for a minimum of 1000 ohms.

In rate pulse output mode, the transistor has a duty cycle of 50%.

Totalizing Pulse

When used to transmit a totalizing pulse, the digital output sends a fixed width (33 mS) pulse that follows the display totalizer. For each increment of the totalizer, the digital output sends 1 pulse. The duration of the pulse is 33 mS with an amplitude approximately equal to the level of +V. See "*Totalizer Page*" on page 55 to set totalizer parameters.

NOTE: The totalizing pulse output can be set for total net, total positive, total negative, total Doppler, energy net, energy positive and energy negative.

Analog Outputs

Analog outputs are signals that change continuously over time. In most control applications, analog signals range continuously over a specified current or voltage. The DXN offers a DC voltage output and two styles of 4...20 mA current output. See *I/O > Set Out*.

Voltage Output (10V DC Max)

The voltage output is configured for 0...10V DC. Analog signals represent continuously variable measurements.

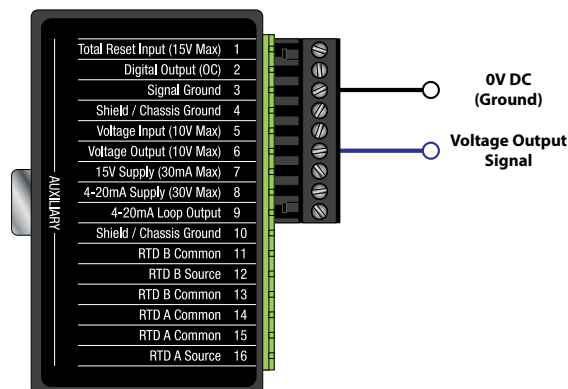

Figure 121: Voltage output connection

4...20 mA Current Loop Output (Current Sinking)

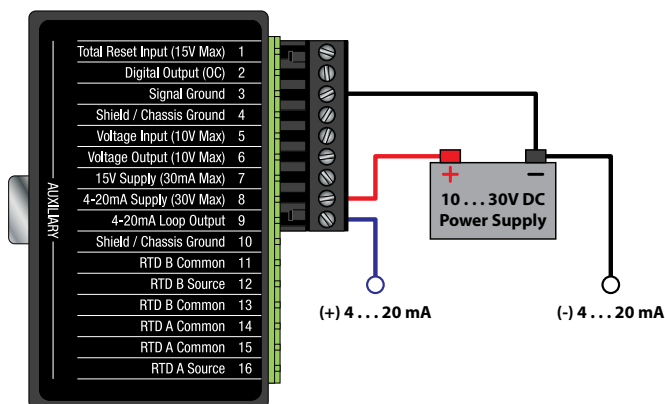

Figure 122: 4...20 mA current sinking output

The 4...20 mA output interfaces with most recording and logging systems by transmitting an analog current signal that is proportional to system flow rate. The 4...20 mA output is internally powered (current sourcing) and can span negative to positive flow/energy rates.

The 4...20 mA output is driven from a +15V DC source located within the meter. The source is isolated from earth ground connections within the DXN. The 4...20 mA output signal is available between the 4...20 mA Out and Signal Ground terminals.

4...20 mA Current Output (Current Sourcing)

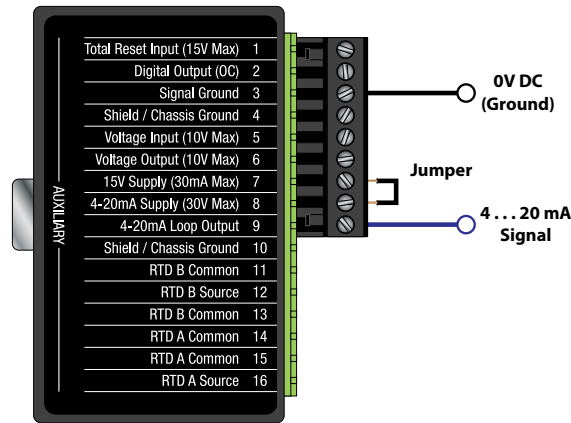

Figure 123: 4...20 mA current sourcing output

The current output from the DXN can also be configured to source current. With terminals 6 and 7 jumpered together.

15V DC Supply (30 mA Max)

The DXN has a built in power supply that can be used to power current or voltage sensors external to the meter.

4...20 mA Supply (30V DC Max)

RTD Connections

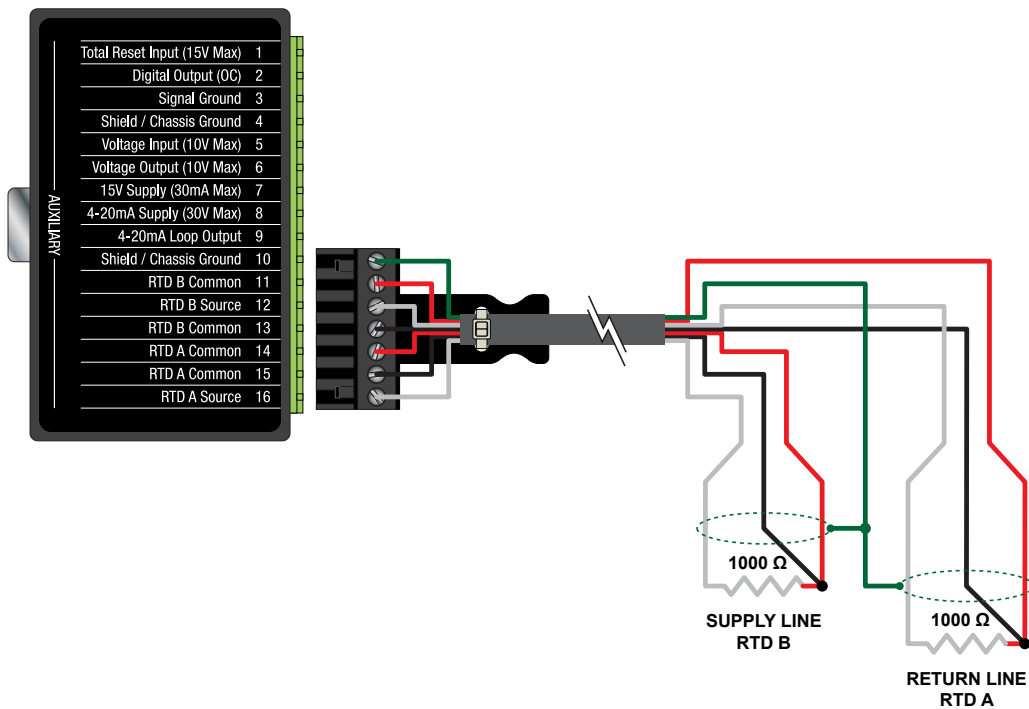

Figure 124: RTD connections

UPGRADING SOFTWARE

IMPORTANT

The Dynasonics USB Flash Drive is formatted in FAT/FAT32. NTFS (New Technology File System) formats do not work.

The upgrade is supplied as a self extracting zip file and must be expanded on a PC before it can be loaded into the DXN.

1. Save the supplied zip file to a convenient place on the computer's hard drive.
2. Double-click on the PortableFlow meter_YYYYMMDD_RevX.zip file to start the extraction process. The completed extraction should open the zip file and place the contents in a folder named "PortableFlow meter" on the hard drive.

NOTE: The "YYYYMMDD" indicates the year, month, and day of the current revision. The "X" in the file name stands for the current revision letter.

Name ▲	Date modified	Type	Size
 PortableFlowmeter	4/12/2013 12:20 PM	File Folder	

3. When the extraction process is complete, copy the **entire "PortableFlow meter" folder** to a USB flash drive.
4. Start the flow meter and select the *Main > Meters* screen.

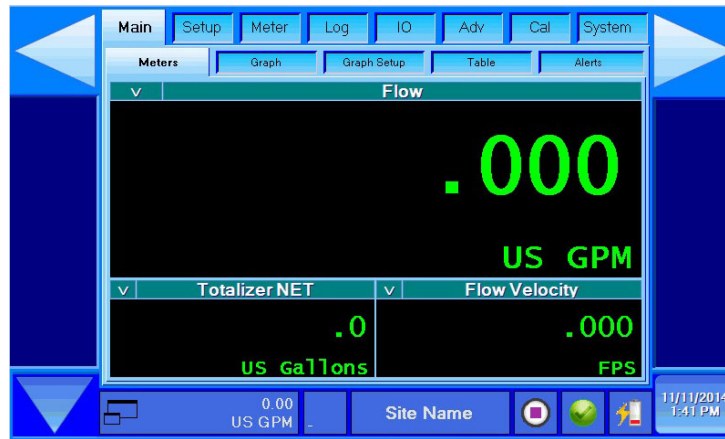

NOTE: Revision E and later of the DXN firmware has multi-language capabilities. To change the language displayed on the menu tabs, press the language button until the proper language is displayed on the screen.



English



German

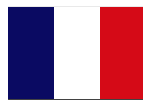

French



Spanish

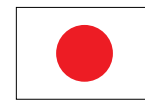

Japanese



Russian



Portuguese



Italian



Dutch



Swedish



Norwegian

5. Insert the thumb drive into the USB port on the rear of the flow meter.
6. From the *Main > Meters* screen, press the **System** tab on the far right of the top menu display.
7. From the *System* screen, select the **Update** page.
8. Press **Quit Meter to Manage / Update**.

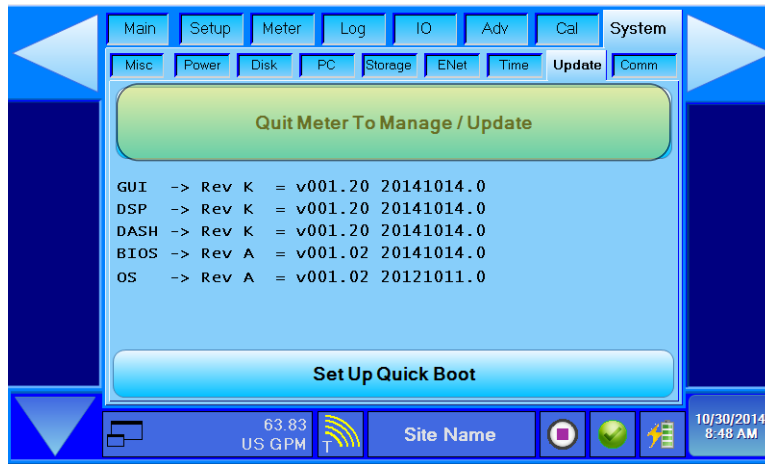

9. Press **Software Update**.

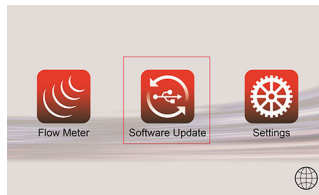

10. Press **Unlock** Step 1: Unlock System (Reboot).

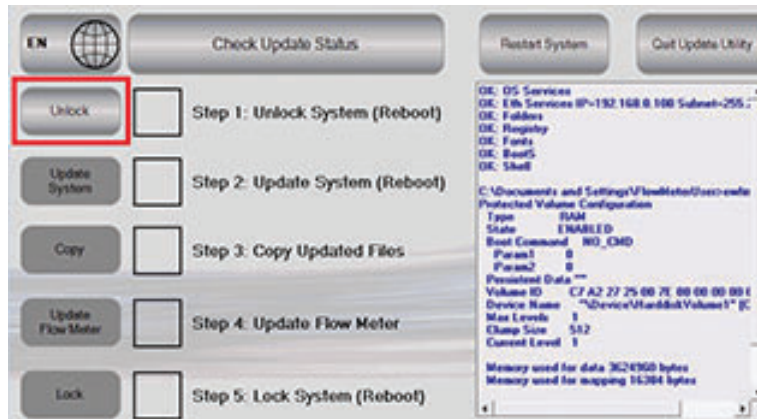

11. A small panel in the center of the screen says "Reboot Required." *Remove the flash drive* and press **OK**.

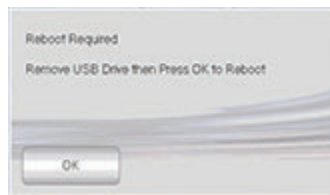

12. After the reboot, the screen shows a grayed-out *Software Update* button. When the update drive is inserted, the grayed out button illuminates. Press **Start Updater** after it illuminates.

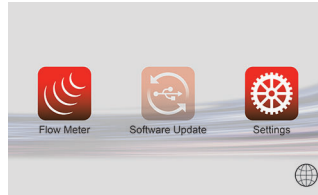

13. The meter returns to the *Update* screen. Press **Update System** Step 2: Update System (Reboot).

NOTE: If this step was completed in a previous system update, the update utility may skip directly to **Copy** Step 3: Copy Updated Files.

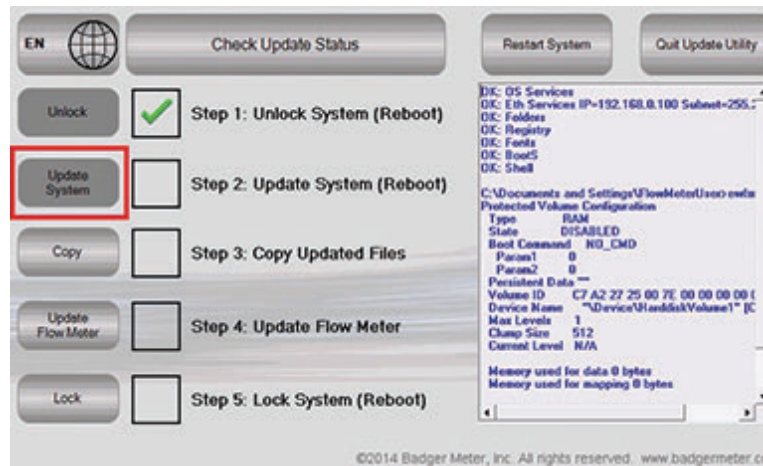

When the update process is complete, a green checkmark displays in the *Update System (Reboot)* box. The screen says "Reboot Required".

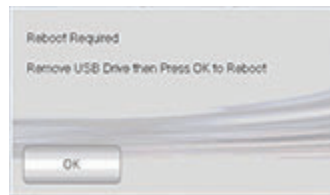

14. Remove the USB Update Drive and press **OK**.

When the opening screen appears, insert the USB Update Drive. The “Software Update” message again becomes selectable.

15. Press **Start Updater**.

16. Press **Copy** Step 3: Copy Updated Files. The text area to the right displays a series of status messages that ends with “Copying Files Complete 100 Files”.

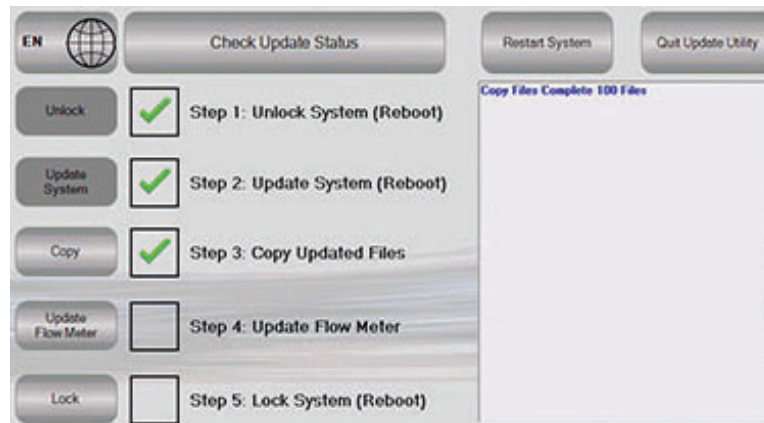
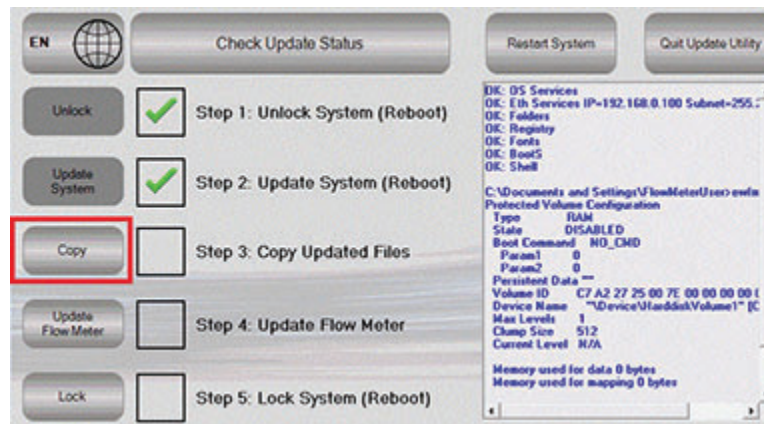

NOTE: If the process hangs-up, press **Copy** a second time to clear the hang. The process may take a few minutes to complete. When the process is complete, use the scroll bars in the message area find to the message “!Successful Update!...Exiting Reprogramming Mode”. This verifies that the updating process has terminated.

17. Press **Update Flow Meter** Step 4: Update Flow Meter. A short process runs again with text filling the text area

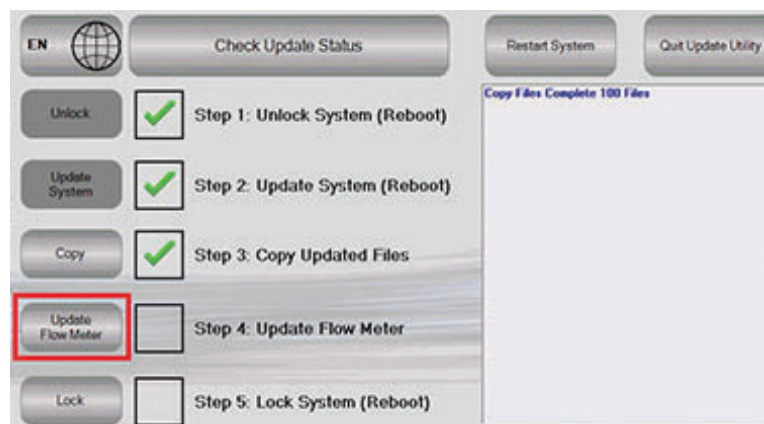

When the update process completes, green checkmarks appear in the boxes next to steps 1, 2, 3 and 4.

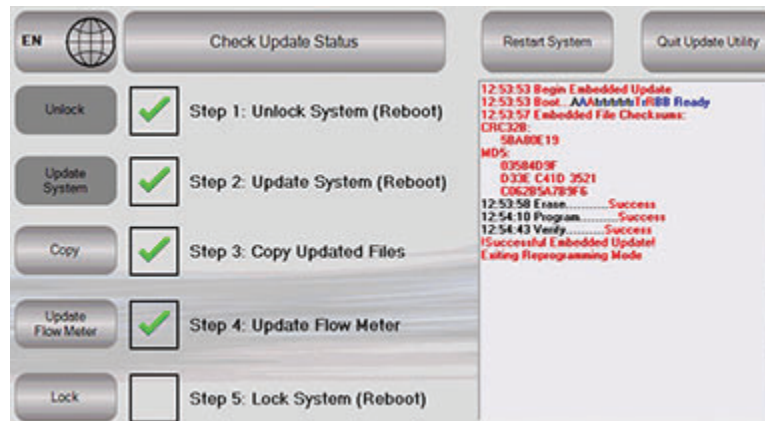

18. Press **Lock** Step 5: Lock System (Reboot), remove the USB drive and press **OK** to reboot.

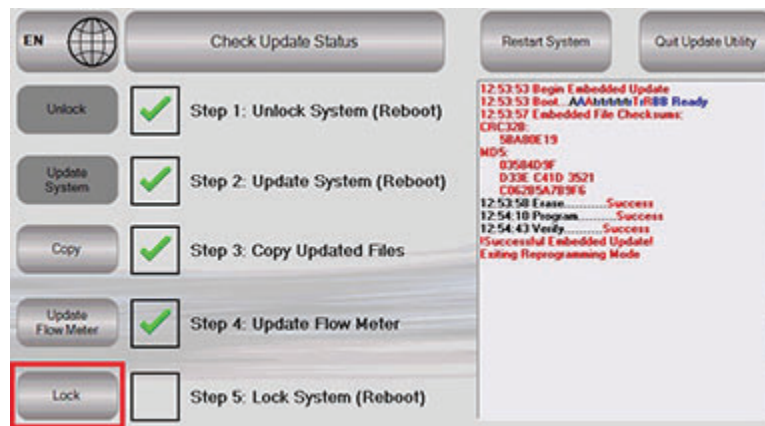

NOTE: If the thumb drive is not removed before you press **OK**, the unit may lock-up. The error message "Lock EWF Fail" may also appear in the text area. Remove the thumb drive. When the meter returns to the screen with the grayed-out *Software Update* button, press **Start Flow Meter** to resume normal operations.

See the last page for additional instruction on clearing a lock-up. When the thumb drive is removed the device may continue on to a system reboot but hang at the Dynasonics splash screen.

This condition requires a hard reboot. Press and hold the main power button until the unit turns off. Press the power button again to start the meter.

Quick Boot

1. To enable *Quick Boot*, from the main screen, select **System > Update** and then press **Set Up Quick Boot**.

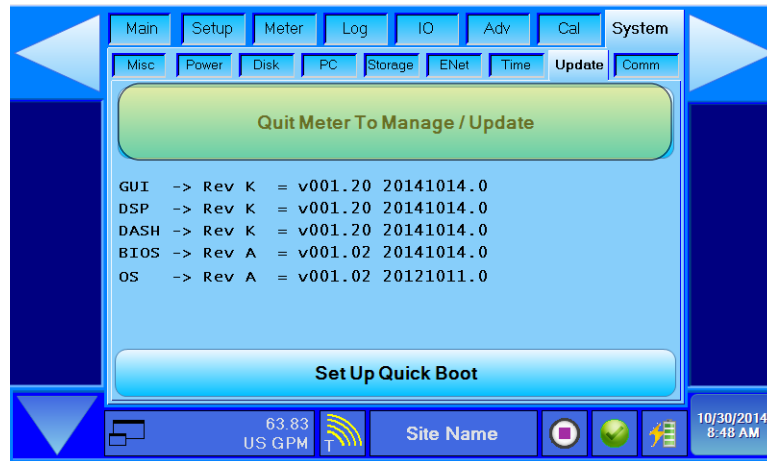

The application closes, reverting to the system menu.

2. Press **Start Flow Meter** again. The unit enters a hibernation process and shuts down. On the next power up, the unit starts in *Quick Boot* mode.

MICROSOFT SOFTWARE LICENSE TERMS FOR WINDOWS XP EMBEDDED AND WINDOWS EMBEDDED STANDARD RUNTIME

These license terms are an agreement between you and Badger Meter. Please read them. They apply to the software included on this device. The software also includes any separate media on which you received the software.

The software on this device includes software licensed from Microsoft Corporation or its affiliate.

The terms also apply to any Microsoft

- Updates,
- Supplements,
- Internet-based services, and
- Support services

for this software, unless other terms accompany those items. If so, those terms apply. If you obtain updates or supplements directly from Microsoft, then Microsoft, and not Badger Meter, licenses those to you.

As described below, using some features also operates as your consent to the transmission of certain standard computer information for Internet-based services.

By using the software, you accept these terms. If you do not accept them, do not use or copy the software. Instead, contact Badger Meter to determine its return policy for a refund or credit.

If you comply with these license terms, you have the rights below.

Use Rights

You may use the software on the device with which you acquired the software.

Additional Licensing Requirements and/or Use Rights

Specific Use

Badger Meter designed this device for a specific use. You may only use the software for that use.

Other Software

You may use other programs with the software as long as the other programs

- Directly support the manufacturer's specific use for the device, or
- Provide system utilities, resource management, or anti-virus or similar protection.

Software that provides consumer or business tasks or processes may not be run on the device. This includes email, word processing, spreadsheet, database, scheduling and personal finance software. The device may use terminal services protocols to access such software running on a server.

Device Connections

You may use terminal services protocols to connect the device to another device running business task or processes software such as email, word processing, scheduling or spreadsheets.

You may allow up to ten other devices to access the software to use

- File Services,
- Print Services,
- Internet Information Services, and
- Internet Connection Sharing and Telephony Services.

The ten connection limit applies to devices that access the software indirectly through multiplexing or other software or hardware that pools connections. You may use unlimited inbound connections at any time via TCP/IP.

Scope of License

The software is licensed, not sold. This agreement only gives you some rights to use the software. Badger Meter and Microsoft reserve all other rights. Unless applicable law gives you more rights despite this limitation, you may use the software only as expressly permitted in this agreement. In doing so, you must comply with any technical limitations in the software that allow you to use it only in certain ways. For more information, see the software documentation or contact Badger Meter. Except and only to the extent permitted by applicable law despite these limitations, you may not:

- Work around any technical limitations in the software;
- Reverse engineer, decompile or disassemble the software;
- Make more copies of the software than specified in this agreement;
- Rent, lease or lend the software; or
- Use the software for commercial software hosting services.

Except as expressly provided in this agreement, rights to access the software on this device do not give you any right to implement Microsoft patents or other Microsoft intellectual property in software or devices that access this device.

You may use remote access technologies in the software such as Remote Desktop to access the software remotely from another device. You are responsible for obtaining any licenses required for use of these protocols to access other software.

Remote Boot Feature

If Badger Meter enabled the device Remote Boot feature of the software, you may

- (i) use the Remote Boot Installation Service (RBIS) tool only to install one copy of the software on your server and to deploy the software on licensed devices as part of the Remote Boot process; and
- (ii) use the Remote Boot Installation Service only for deployment of the software to devices as part of the Remote Boot process; and
- (iii) download the software to licensed devices and use it on them.

For more information, please see the device documentation or contact Badger Meter.

Internet-Based Services

Microsoft provides Internet-based services with the software. Microsoft may change or cancel them at any time.

Consent for Internet-Based Services

The software features described below connect to Microsoft or service provider computer systems over the Internet. In some cases, you will not receive a separate notice when they connect. You may switch off these features or not use them. For more information about these features, visit

<http://www.microsoft.com/windowsxp/downloads/updates/sp2/docs/priV ACy.msp>.

By using these features, you consent to the transmission of this information. Microsoft does not use the information to identify or contact you.

Computer Information

The following features use Internet protocols, which send to the appropriate systems computer information, such as your Internet protocol address, the type of operating system, browser and name and version of the software you are using, and the language code of the device where you installed the software. Microsoft uses this information to make the Internet-based services available to you.

Web Content Features

Features in the software can retrieve related content from Microsoft and provide it to you. To provide the content, these features send to Microsoft the type of operating system, name and version of the software you are using, type of browser and language code of the device where the software was installed. Examples of these features are clip art, templates, online training, online assistance and Appshelp. These features only operate when you activate them. You may choose to switch them off or not use them.

Digital Certificates

The software uses digital certificates. These digital certificates confirm the identity of Internet users sending X.509 standard encrypted information. The software retrieves certificates and updates certificate revocation lists. These security features operate only when you use the Internet.

Auto Root Update

The Auto Root Update feature updates the list of trusted certificate authorities. You can switch off the Auto Root Update feature.

Windows Media Player

When you use Windows Media Player, it checks with Microsoft for

- Compatible online music services in your region;
- New versions of the player; and
- Codecs if your device does not have the correct ones for playing content. You can switch off this feature. For more information, go to: <http://microsoft.com/windows/windowsmedia/mp10/priV ACy.aspx>.

Windows Media Digital Rights Management

Content owners use Windows Media digital rights management technology (WMDRM) to protect their intellectual property, including copyrights. This software and third party software use WMDRM to play and copy WMDRM-protected content. If the software fails to protect the content, content owners may ask Microsoft to revoke the software's ability to use WMDRM to play or copy protected content. Revocation does not affect other content. When you download licenses for protected content, you agree that Microsoft may include a revocation list with the licenses. Content owners may require you to upgrade WMDRM to access their content. Microsoft software that includes WMDRM will ask for your consent prior to the upgrade. If you decline an upgrade, you will not be able to access content that requires the upgrade. You may switch off WMDRM features that access the Internet. When these features are off, you can still play content for which you have a valid license.

Misuse of Internet-based Services

You may not use these services in any way that could harm them or impair anyone else's use of them. You may not use the services to try to gain unauthorized access to any service, data, account or network by any means.

Windows Update Agent (also known as Software Update Services)

The software on the device includes Windows Update Agent (WUA) functionality that may enable your device to connect to and access updates (Windows Updates) from a server installed with the required server component. Without limiting any other disclaimer in this Microsoft Software License Terms or any EULA accompanying a Windows Update, you acknowledge and agree that no warranty is provided by MS, Microsoft Corporation or their affiliates with respect to any Windows Update that you install or attempt to install on your device.

Product Support

Contact Badger Meter for support options. See the support number provided with the device.

Backup Copy

You may make one backup copy of the software. You may use it only to reinstall the software on the device.

Proof of License

If you acquired the software on the device, or on a disc or other media, a genuine Certificate of Authenticity label with a genuine copy of the software identifies licensed software. To be valid, this label must be affixed to the device, or included on or in the Badger Meter software packaging. If you receive the label separately, it is not valid. You should keep the label on the device or packaging to prove that you are licensed to use the software. To identify genuine Microsoft software, see <http://www.howtotell.com>.

Transfer to a Third Party

You may transfer the software only with the device, the Certificate of Authenticity label, and these license terms directly to a third party. Before the transfer, that party must agree that these license terms apply to the transfer and use of the software. You may not retain any copies of the software including the backup copy.

Not Fault Tolerant

The software is not fault tolerant. Badger Meter installed the software on the device and is responsible for how it operates on the device.

Restricted Use

The Microsoft software was designed for systems that do not require fail-safe performance. You may not use the Microsoft software in any device or system in which a malfunction of the software would result in foreseeable risk of injury or death to any person. This includes operation of nuclear facilities, aircraft navigation or communication systems and air traffic control.

No Warranties for the Software

The software is provided as is. You bear all risks of using it. Microsoft gives no express warranties, guarantees or conditions. Any warranties you receive regarding the device or the software do not originate from, and are not binding on, Microsoft or its affiliates. When allowed by your local laws, Badger Meter and Microsoft exclude implied warranties of merchantability, fitness for a particular purpose and non-infringement.

Liability Limitations

You can recover from Microsoft and its affiliates only direct damages up to two hundred fifty U.S. Dollars (U.S. \$250.00). You cannot recover any other damages, including consequential, lost profits, special, indirect or incidental damages.

This limitation applies to:

- Anything related to the software, services, content (including code) on third party internet sites, or third party programs; and
- Claims for breach of contract, breach of warranty, guarantee or condition, strict liability, negligence, or other tort to the extent permitted by applicable law.
- It also applies even if Microsoft should have been aware of the possibility of the damages. The above limitation may not apply to you because your country may not allow the exclusion or limitation of incidental, consequential or other damages.

Export Restrictions

The software is subject to United States export laws and regulations. You must comply with all domestic and international export laws and regulations that apply to the software. These laws include restrictions on destinations, end users and end use. For additional information, see www.microsoft.com/exporting.

K FACTORS

Description

The K factor (with regards to flow) is the number of pulses that must be accumulated to equal a particular volume of fluid. You can think of each pulse as representing a small fraction of the totalizing unit.

An example might be a K factor of 1000 (pulses per gallon). This means that if you were counting pulses, when the count total reached 1000, you would have accumulated one gallon of liquid. Using the same reasoning, each individual pulse represents an accumulation of 1/1000 of a gallon. This relationship is independent of the time it takes to accumulate the counts.

The frequency aspect of K factors is a little more confusing because it also involves the flow rate. The same K factor number, with a time frame added, can be converted into a flow rate. If you accumulated 1000 counts (one gallon) in one minute, then your flow rate would be one gpm. The output frequency, in Hz, is found simply by dividing the number of counts (1000) by the number of seconds in a minute (60) to get the output frequency.

$1000 \div 60 = 16.6666$ Hz. If you were looking at the pulse output on a frequency counter, an output frequency of 16.666 Hz would be equal to one gpm. If the frequency counter registered 33.333 Hz (2×16.666 Hz), then the flow rate would be two gpm.

Finally, if the flow rate is two gpm, then the accumulation of 1000 counts would take place in 30 seconds because the flow rate, and hence the speed that the 1000 counts is accumulated, is twice as great.

Calculating K Factors

Many styles of flow meters are capable of measuring flow in a wide range of pipe sizes. Because the pipe size and volumetric units the flow meter will be used on vary, it may not be possible to provide a discrete K factor. In the event that a discrete K factor is not supplied then the velocity range of the flow meter is usually provided along with a maximum frequency output.

The most basic K factor calculation requires that an accurate flow rate and the output frequency associated with that flow rate be known.

Example 1

Known values are:

$$\text{Frequency} = 700 \text{ Hz}$$

$$\text{Flow Rate} = 48 \text{ gpm}$$

$$700 \text{ Hz} \times 60 \text{ sec} = 42,000 \text{ pulses per min}$$

$$\text{K factor} = \frac{42,000 \text{ pulses per min}}{48 \text{ gpm}} = 875 \text{ pulses per gallon}$$

Example 2

Known values are:

$$\text{Full Scale Flow Rate} = 85 \text{ gpm}$$

$$\text{Full Scale Output Frequency} = 650 \text{ Hz}$$

$$650 \text{ Hz} \times 60 \text{ sec} = 39,000 \text{ pulses per min}$$

$$\text{K factor} = \frac{39,000 \text{ pulses per min}}{85 \text{ gpm}} = 458.82 \text{ pulses per gallon}$$

The calculation is a little more complex if velocity is used because you first must convert the velocity into a volumetric flow rate to be able to compute a K factor.

To convert a velocity into a volumetric flow, the velocity measurement and an accurate measurement of the inside diameter of the pipe must be known. Also needed is the fact that one US gallon of liquid is equal to 231 cubic inches.

Example 3

Known values are:

$$\text{Velocity} = 4.3 \text{ ft/sec}$$

$$\text{Inside Diameter of Pipe} = 3.068 \text{ in.}$$

Find the area of the pipe cross section.

$$\text{Area} = \pi r^2$$

$$\text{Area} = \pi \left(\frac{3.068}{2} \right)^2 = \pi \times 2.35 = 7.39 \text{ in}^2$$

Find the volume in one foot of travel.

$$7.39 \text{ in}^2 \times 12 \text{ in. (1 ft)} = \frac{88.71 \text{ in}^3}{\text{ft}}$$

What portion of a gallon does one foot of travel represent?

$$\frac{88.71 \text{ in}^3}{231 \text{ in}^3} = 0.384 \text{ gallons}$$

So for every foot of fluid travel 0.384 gallons will pass.

What is the flow rate in gpm at 4.3 ft/sec?

$$0.384 \text{ gallons} \times 4.3 \text{ FPS} \times 60 \text{ sec (1 min)} = 99.1 \text{ gpm}$$

Now that the volumetric flow rate is known, all that is needed is an output frequency to determine the K factor.

Known values are:

$$\text{Frequency} = 700 \text{ Hz (By measurement)}$$

$$\text{Flow Rate} = 99.1 \text{ gpm (By calculation)}$$

$$700 \text{ Hz} \times 60 \text{ sec} = 42,000 \text{ pulses per gallon}$$

$$\text{K factor} = \frac{42,000 \text{ pulses per min}}{99.1 \text{ gpm}} = 423.9 \text{ pulses per gallon}$$

SPECIFIC HEAT CAPACITY VALUES FOR FLUIDS

Temperature		Specific Heat
32...212° F	0...100° C	1.00 Btu/lb° F
250° F	121° C	1.02 Btu/lb° F
300° F	149° C	1.03 Btu/lb° F
350° F	177° C	1.05 Btu/lb° F

Table 25: Specific heat capacity values for water

Fluid	Temperature		Specific Heat
Ethanol	32° F	0° C	0.65 Btu/lb° F
Methanol	54° F	12° C	0.60 Btu/lb° F
Brine	32° F	0° C	0.71 Btu/lb° F
Brine	60° F	15° C	0.72 Btu/lb° F
Sea Water	63° F	17° C	0.94 Btu/lb° F

Table 26: Specific heat capacity values for other common fluids

Temperature		Ethylene Glycol Solution (glycol/water — by Volume)						
		25%	30%	40%	50%	60%	65%	100%
-40° F	-40° C	n/a	n/a	n/a	n/a	0.68 Btu/lb° F	0.70 Btu/lb° F	n/a
0° F	-17.8° C	n/a	n/a	0.83 Btu/lb° F	0.78 Btu/lb° F	0.72 Btu/lb° F	0.70 Btu/lb° F	0.54 Btu/lb° F
40° F	4.4° C	0.91 Btu/lb° F	0.89 Btu/lb° F	0.85 Btu/lb° F	0.80 Btu/lb° F	0.75 Btu/lb° F	0.72 Btu/lb° F	0.56 Btu/lb° F
80° F	26.7° C	0.92 Btu/lb° F	0.90 Btu/lb° F	0.86 Btu/lb° F	0.82 Btu/lb° F	0.77 Btu/lb° F	0.74 Btu/lb° F	0.59 Btu/lb° F
120° F	84.9° C	0.93 Btu/lb° F	0.92 Btu/lb° F	0.88 Btu/lb° F	0.83 Btu/lb° F	0.79 Btu/lb° F	0.77 Btu/lb° F	0.61 Btu/lb° F
160° F	71.1° C	0.94 Btu/lb° F	0.93 Btu/lb° F	0.89 Btu/lb° F	0.85 Btu/lb° F	0.81 Btu/lb° F	0.79 Btu/lb° F	0.64 Btu/lb° F
200° F	93.3° C	0.95 Btu/lb° F	0.94 Btu/lb° F	0.91 Btu/lb° F	0.87 Btu/lb° F	0.83 Btu/lb° F	0.81 Btu/lb° F	0.66 Btu/lb° F
240° F	115.6° C	n/a	n/a	n/a	n/a	n/a	0.83 Btu/lb° F	0.69 Btu/lb° F

Table 27: Specific heat capacity values for ethylene glycol/water

SPECIFICATIONS

Process Monitoring Inputs/Outputs

Connector	15-pin high-density DSUB	
Breakout Box	0.2 in. quick disconnect screw terminal; 15-pin to adapter box; 6 ft (1.8 m) of cable (DSUB to DSUB connectors)	
Analog Inputs/Outputs	Energy/Temperature (2) tab type PT1000 RTDs. Can handle various temperature ranges from $-58...570^{\circ}\text{F}$ ($-50...300^{\circ}\text{C}$), based on RTD type Current output 4...20 mA active/passive 1% accuracy	
Sensor Supply	14V @ 50 mA max for powering current or voltage sensors	
Digital Output	Open collector, external pull-up; Rate or total pulse user selectable	
	Rate pulse: 0...1000 Hz	Total pulse: 33 ms duration
Digital Input	Totalizer reset, external pull-up, software enabled	
Auxiliary Inputs	Voltage input. 0...5V or 0...10V, 1% accuracy, Software scaling and control, 80 k Ohms input impedance, Data log capable	
Voltage Output	0...5V or 0...10V output voltage, 1% accuracy, Software scaling and control, 100 Ohms output impedance	

System

Measurement Type	Flow: Ultrasonic transit time and Doppler (reflection of acoustic signals); hybrid operation; liquid thermal energy Pipe wall thickness: Ultrasonic transit time of acoustic signals		
Liquid Types	Liquid dominant fluids, acoustically conductive		
Velocity Range	Transit Time: Bi-directional to 40 FPS (12 MPS)	Doppler: Uni-directional to 40 FPS (12 MPS)	
Flow Rate Accuracy	Transit Time: $\pm 1\%$ of reading or ± 0.01 FPS (0.003 MPS), whichever is greater.	Doppler: 2% of full scale	
Flow Sensitivity	0.001 FPS (0.0003 MPS)		
Repeatability	$\pm 0.1\%$ of reading		
Temperature Accuracy	Absolute: 0.5°F (1°C)	Difference: 0.2°F (0.5°C)	Resolution: 0.02°F (0.01°C)
Logging	Greater than 300 sites stored in 1 GB; download to USB flash drive		
Update Time	0.1...10 seconds update/filter rate. Transit time, up to 50 Hz high speed mode		
Battery	Internal 11.1V lithium ion battery, 75 W-hr. Provides 6...9 hr of continuous operation with battery and indefinitely on external power. Complete charge at $32...104^{\circ}\text{F}$ ($0...40^{\circ}\text{C}$), 4 hours when powered off.		
Power Requirements	Transmitter: 10...30V DC via 3-pin connector, 40 W, minimum; 3.6 A re-settable fuse Supplies: Desktop adapter: 100...240V AC 50/60 Hz 50 W 10...18 V; Cigarette lighter adapter: 5 A fused		
Power Cords	North American plug (2 flat & 1 round prong; NEMA 5/15P); Chinese plug (3 flat prongs; GB2099); Euro plug (2 round prongs; CEE7/7); U.K./Singapore plug (3 rectangular prongs; BS1363A) Japanese plug (2 flat & 1 round, JIS8303, w/ 3-2 prong adapter) Australian plug (3 flat prongs, AS3112)		
Display	800 x 480 WVGA color outdoor readable display; gloved-operation resistive touch screen 6 in. x 3.6 in. (152.4 mm x 41.44 mm)		
Ambient Conditions	Battery powered: $-4...110^{\circ}\text{F}$ ($-20...45^{\circ}\text{C}$)	Externally powered: $-20...140^{\circ}\text{F}$ ($-30...60^{\circ}\text{C}$)	
Storage Temperature	Do not exceed 175°F (80°C)		
Enclosure	Water/dust resistant		
User Menu	Multi-language: English, Spanish, German, French, Portuguese, Japanese, Russian, Italian, Dutch, Norwegian, and Swedish		
Compliance	Safety: UL61010-1, CSA C22.2 No. 61010-1, EN61010-1 Directives: 2006/95/EC low Voltage, 2004/108/EC EMC		

Transducers

Pipe Sizes	1/2 in. and larger; US standard pipe tables are built into user Interface			
Housing Material	DTTSU: CPVC, Ultem®, and anodized aluminum track system; nickel-plated brass connector with Teflon® insulation	DTTR: PBT glass filled, Ultem, Nylon cord grip, PVC cable jacket	DTTN/DTTL/DT94: CPVC, Ultem®; nickel-plated brass connector with Teflon® insulation	
Pipe Surface Temperature	DTTN/DTTSU/DTTL: -40...194° F (-40...90° C)	DTTR: -40...250° F (-40...121° C)	DT94: -40...194° F (-40...90° C)	
Transducer Frequency	DTTSU: 2 MHz	DTTN/DTTR: 1 MHz	DTTL: 500 kHz	DT94: 625 kHz
Cable Length	Transit time: 20 ft (6 m) paired coaxial cable, BNC to BNC, Doppler: 20 ft (6 m) paired coaxial cable, BNC to 4-pin			
Pipe Thickness	Dual mode transducer with 6 ft (1.8 m) of cable (BNC ends)			
RTDs	2 x platinum 385, 1000 Ohm, 3-wire PVC jacketed cable standard with quick connector			

NORTH AMERICAN PIPE SCHEDULES

Steel, Stainless Steel, PVC Pipe, Standard Classes

NPS in.	OD in.	SCH 60		X STG.		SCH 80		SCH 100		SCH 120/140		SCH 180	
		ID in.	Wall in.	ID in.	Wall in.	ID in.	Wall in.	ID in.	Wall in.	ID in.	Wall in.	ID in.	Wall in.
1	1.315			0.957	0.179	0.957	0.179					0.815	0.250
1.25	1.660			1.278	0.191	1.278	0.191					1.160	0.250
1.5	1.900			1.500	0.200	1.500	0.200					1.338	0.281
2	2.375			1.939	0.218	1.939	0.218					1.687	0.344
2.5	2.875			2.323	0.276	2.323	0.276					2.125	0.375
3	3.500			2.900	0.300	2.900	0.300					2.624	0.438
3.5	4.000			3.364	0.318	3.364	0.318						
4	4.500			3.826	0.337	3.826	0.337			3.624	0.438	3.438	0.531
5	5.563			4.813	0.375	4.813	0.375			4.563	0.500	4.313	0.625
6	6.625			5.761	0.432	5.761	0.432			5.501	0.562	5.187	0.719
8	8.625	7.813	0.406	7.625	0.500	7.625	0.500	7.437	0.594	7.178	0.719	6.183	1.221
10	10.75	9.750	0.500	9.75	0.500	9.562	0.594	9.312	0.719	9.062	0.844	8.500	1.125
12	12.75	11.626	0.562	11.75	0.500	11.37	0.690	11.06	0.845	10.75	1.000	10.12	1.315
14	14.00	12.814	0.593	13.00	0.500	12.50	0.750	12.31	0.845	11.81	1.095	11.18	1.410
16	16.00	14.688	0.656	15.00	0.500	14.31	0.845	13.93	1.035	13.56	1.220	12.81	1.595
18	18.00	16.564	0.718	17.00	0.500	16.12	0.940	15.68	1.160	15.25	1.375	14.43	1.785
20	20.00	18.376	0.812	19.00	0.500	17.93	1.035	17.43	1.285	17.00	1.500	16.06	1.970
24	24.00	22.126	0.937	23.00	0.500	21.56	1.220	20.93	1.535	20.93	1.535	19.31	2.345
30	30.00			29.00	0.500								
36	36.00			35.00	0.500								
42	42.00			41.00	0.500								
48	48.00			47.00	0.500								

Table 28: Steel, stainless steel, PVC pipe, standard classes

Steel, Stainless Steel, PVC Pipe, Standard Classes (continued)

NPS in.	OD in.	SCH 5		SCH 10 (Lt Wall)		SCH 20		SCH 30		STD		SCH 40	
		ID in.	Wall in.	ID in.	Wall in.	ID in.	Wall in.	ID in.	Wall in.	ID in.	Wall in.	ID in.	Wall in.
1	1.315	1.185	0.065	1.097	0.109	—	—	—	—	1.049	—	1.049	0.133
1.25	1.660	1.53	0.065	1.442	0.109					1.380		1.380	0.140
1.5	1.900	1.77	0.065	1.682	0.109					1.610		1.610	0.145
2	2.375	2.245	0.065	2.157	0.109					2.067		2.067	0.154
2.5	2.875	2.709	0.083	2.635	0.120					2.469		2.469	0.203
3	3.500	3.334	0.083	3.260	0.120					3.068		3.068	0.216
3.5	4.000	3.834	0.083	3.760	0.120	—	—	—	3.548	—	3.548	0.226	
4	4.500	4.334	0.083	4.260	0.120				4.026	0.237	4.026	0.237	
5	5.563	5.345	0.109	5.295	0.134				5.047	0.258	5.047	0.258	
6	6.625	6.407	0.109	6.357	0.134				6.065	0.280	6.065	0.280	
8	8.625	8.407	0.109	8.329	0.148	8.125	0.250	8.071	0.277	7.981	0.322	7.981	0.322
10	10.75	10.482	0.134	10.42	0.165	10.25	0.250	10.13	0.310	10.02	0.365	10.02	0.365
12	12.75	12.42	0.165	12.39	0.180	12.25	0.250	12.09	0.330	12.00	0.375	11.938	0.406
14	14.00	—	—	13.50	0.250	13.37	0.315	13.25	0.375	13.25	0.375	13.124	0.438
16	16.00			15.50	0.250	15.37	0.315	15.25	0.375	15.25	0.375	15.000	0.500
18	18.00			17.50	0.250	17.37	0.315	17.12	0.440	17.25	0.375	16.876	0.562
20	20.00			19.50	0.250	19.25	0.375	19.25	0.375	19.25	0.375	18.814	0.593
24	24.00			23.50	0.250	23.25	0.375	23.25	0.375	23.25	0.375	22.626	0.687
30	30.00			29.37	0.315	29.00	0.500	29.00	0.500	29.25	0.375	29.25	0.375
36	36.00	35.37	0.315	35.00	0.500	35.00	0.500	35.25	0.375	35.25	0.375		
42	42.00	—	—	—	—	—	—	—	—	41.25	0.375	41.25	0.375
48	48.00									47.25	0.375	47.25	0.375

Figure 18: Steel, stainless steel, PVC pipe, standard classes (continued)

Copper Tubing, Copper and Brass Pipe, Aluminum

Nominal Diameter in.	Copper Tubing in.			Copper & Brass Pipe in.	Alum. in.	Nominal Diameter in.	Copper Tubing in.			Copper & Brass Pipe in.	Alum. in.			
	Type						Type							
	K	L	M				K	L	M					
0.5	OD	0.625	0.625	0.625	0.840	—	3-1/2 in.	OD	3.625	3.625	3.625	4.000	—	
	Wall	0.049	0.040	0.028	0.108			Wall	0.120	0.100	0.083	0.250		
	ID	0.527	0.545	0.569	0.625			ID	3.385	3.425	3.459	3.500		
0.6250	OD	0.750	0.750	0.750	—	—	4 in.	OD	4.125	4.125	4.125	4.500	4.000	
	Wall	0.049	0.042	0.030				Wall	0.134	0.110	0.095	0.095	0.250	
	ID	0.652	0.666	0.690				ID	3.857	3.905	3.935	3.935	4.000	
0.75	OD	0.875	0.875	0.875	1.050	—	4-1/2 in.	OD	—	—	—	—	5.000	
	Wall	0.065	0.045	0.032	0.114			Wall					0.250	
	ID	0.745	0.785	0.811	0.822			ID					4.500	
1	OD	1.125	1.125	1.125	1.315	—	5 in.	OD	5.125	5.125	5.125	5.563	5.000	
	Wall	0.065	0.050	0.035	0.127			Wall	0.160	0.125	0.109	0.250	0.063	
	ID	0.995	1.025	1.055	1.062			ID	4.805	4.875	4.907	5.063	4.874	
1.25	OD	1.375	1.375	1.375	1.660	—	6 in.	OD	6.125	6.125	6.125	6.625	6.000	
	Wall	0.065	0.055	0.042	0.146			Wall	0.192	0.140	0.122	0.250	0.063	
	ID	1.245	1.265	1.291	1.368			ID	5.741	5.845	5.881	6.125	5.874	
1.5.	OD	1.625	1.625	1.625	1.900	—	7 in.	OD	—	—	—	—	7.625	7.000
	Wall	0.072	0.060	0.049	0.150			Wall					0.282	0.078
	ID	1.481	1.505	1.527	1.600			ID					7.062	6.844
2	OD	2.125	2.125	2.125	2.375	—	8 in.	OD	8.125	8.125	8.125	8.625	8.000	
	Wall	0.083	0.070	0.058	0.157			Wall	0.271	0.200	0.170	0.313	0.094	
	ID	1.959	1.985	2.009	2.062			ID	7.583	7.725	7.785	8.000	7.812	
2.5	OD	2.625	2.625	2.625	2.875	2.500	10 in.	OD	10.125	10.125	10.125	10.000	—	
	Wall	0.095	0.080	0.065	0.188	0.050		Wall	0.338	0.250	0.212	0.094	—	
	ID	2.435	2.465	2.495	2.500	2.400		ID	9.449	9.625	9.701	9.812	—	
3	OD	3.125	3.125	3.125	3.500	3.000	12 in.	OD	12.125	12.125	12.125	—	—	
	Wall	0.109	0.090	0.072	0.219	0.050		Wall	0.405	0.280	0.254	—	—	
	ID	2.907	2.945	2.981	3.062	2.900		ID	11.315	11.565	11.617	—	—	

Table 29: Copper tubing, copper and brass pipe, aluminum

Cast Iron Pipe, Standard Classes, 3...20 inch

Size in.		Class in.							
		A	B	C	D	E	F	G	H
3	OD	3.80	3.96	3.96	3.96	—	—	—	—
	Wall	0.39	0.42	0.45	0.48				
	ID	3.02	3.12	3.06	3.00				
4	OD	4.80	5.00	5.00	5.00	—	—	—	—
	Wall	0.42	0.45	0.48	0.52				
	ID	3.96	4.10	4.04	3.96				
6	OD	6.90	7.10	7.10	7.10	7.22	7.22	7.38	7.38
	Wall	0.44	0.48	0.51	0.55	0.58	0.61	0.65	0.69
	ID	6.02	6.14	6.08	6.00	6.06	6.00	6.08	6.00
8	OD	9.05	9.05	9.30	9.30	9.42	9.42	9.60	9.60
	Wall	0.46	0.51	0.56	0.60	0.66	0.66	0.75	0.80
	ID	8.13	8.03	8.18	8.10	8.10	8.10	8.10	8.00
10	OD	11.10	11.10	11.40	11.40	11.60	11.60	11.84	11.84
	Wall	0.50	0.57	0.62	0.68	0.74	0.80	0.86	0.92
	ID	10.10	9.96	10.16	10.04	10.12	10.00	10.12	10.00
12	OD	13.20	13.20	13.50	13.50	13.78	13.78	14.08	14.08
	Wall	0.54	0.62	0.68	0.75	0.82	0.89	0.97	1.04
	ID	12.12	11.96	12.14	12.00	12.14	12.00	12.14	12.00
14	OD	15.30	15.30	15.65	15.65	15.98	15.98	16.32	16.32
	Wall	0.57	0.66	0.74	0.82	0.90	0.99	1.07	1.16
	ID	14.16	13.98	14.17	14.01	14.18	14.00	14.18	14.00
16	OD	17.40	17.40	17.80	17.80	18.16	18.16	18.54	18.54
	Wall	0.60	0.70	0.80	0.89	0.98	1.08	1.18	1.27
	ID	16.20	16.00	16.20	16.02	16.20	16.00	16.18	16.00
18	OD	19.50	19.50	19.92	19.92	20.34	20.34	20.78	20.78
	Wall	0.64	0.75	0.87	0.96	1.07	1.17	1.28	1.39
	ID	18.22	18.00	18.18	18.00	18.20	18.00	18.22	18.00
20	OD	21.60	21.60	22.06	22.06	22.54	22.54	23.02	23.02
	Wall	0.67	0.80	0.92	1.03	1.15	1.27	1.39	1.51
	ID	20.26	20.00	20.22	20.00	20.24	20.00	20.24	20.00

Table 30: Cast iron pipe, standard classes, 3...20 inch

Cast Iron Pipe, Standard Classes, 24...84 inch

Size in.		Class in.							
		A	B	C	D	E	F	G	H
24	OD	25.80	25.80	26.32	26.32	26.90	26.90	27.76	27.76
	Wall	0.76	0.98	1.05	1.16	1.31	1.45	1.75	1.88
	ID	24.28	24.02	24.22	24.00	24.28	24.00	24.26	24.00
30	O D	31.74	32.00	32.40	32.74	33.10	33.46	—	
	Wall	0.88	1.03	1.20	1.37	1.55	1.73		
	ID	29.98	29.94	30.00	30.00	30.00	30.00		
36	OD	37.96	38.30	38.70	39.16	39.60	40.04	—	
	Wall	0.99	1.15	1.36	1.58	1.80	2.02		
	ID	35.98	36.00	35.98	36.00	36.00	36.00		
42	OD	44.20	44.50	45.10	45.58	—			
	Wall	1.10	1.28	1.54	1.78				
	ID	42.00	41.94	42.02	42.02				
48	OD	50.55	50.80	51.40	51.98	—			
	Wall	1.26	1.42	1.71	1.99				
	ID	47.98	47.96	47.98	48.00				
54	OD	56.66	57.10	57.80	58.40	—			
	Wall	1.35	1.55	1.90	2.23				
	ID	53.96	54.00	54.00	53.94				
60	OD	62.80	63.40	64.20	64.28	—			
	Wall	1.39	1.67	2.00	2.38				
	ID	60.02	60.06	60.20	60.06				
72	OD	75.34	76.00	76.88	—				
	Wall	1.62	1.95	2.39					
	ID	72.10	72.10	72.10					
84	OD	87.54	88.54	—					
	Wall	1.72	2.22						
	ID	84.10	84.10						

Table 31: Cast iron pipe, standard classes, 24...84 inch

FLUID PROPERTIES

Fluid	Specific Gravity 20° C	Sound Speed		delta-v/° C m/s/° C	Kinematic Viscosity (cSt)	Absolute Viscosity (Cp)
		ft/s	m/s			
Acetate, Butyl	—	4163.9	1270	—	—	—
Acetate, Ethyl	0.901	3559.7	1085	4.4	0.489	0.441
Acetate, Methyl	0.934	3973.1	1211	—	0.407	0.380
Acetate, Propyl	—	4196.7	1280	—	—	—
Acetone	0.79	3851.7	1174	4.5	0.399	0.316
Alcohol	0.79	3960.0	1207	4.0	1.396	1.101
Alcohol, Butyl	0.83	4163.9	1270	3.3	3.239	2.688
Alcohol, Ethyl	0.83	3868.9	1180	4	1.396	1.159
Alcohol, Methyl	0.791	3672.1	1120	2.92	0.695	0.550
Alcohol, Propyl	—	3836.1	1170	—	—	—
Alcohol, Propyl	0.78	4009.2	1222	—	2.549	1.988
Ammonia	0.77	5672.6	1729	6.7	0.292	0.225
Aniline	1.02	5377.3	1639	4.0	3.630	3.710
Benzene	0.88	4284.8	1306	4.7	0.7 11	0.625
Benzol, Ethyl	0.867	4389.8	1338	—	0.797	0.691
Bromine	2.93	2916.7	889	3.0	0.323	0.946
n-Butane	0.60	3559.7	1085	5.8	—	—
Butyrate, Ethyl	—	3836.1	1170	—	—	—
Carbon dioxide	1.10	2752.6	839	7.7	0.137	0.151
Carbon tetrachloride	1.60	3038.1	926	2.5	0.607	0.968
Chloro-benzene	1.11	4176.5	1273	3.6	0.722	0.799
Chloroform	1.49	3211.9	979	3.4	0.550	0.819
Diethyl ether	0.71	3231.6	985	4.9	0.3 11	0.222
Diethyl Ketone	—	4295.1	1310	—	—	—
Diethylene glycol	1.12	5203.4	1586	2.4	—	—
Ethanol	0.79	3960.0	1207	4.0	1.390	1.097
Ethyl alcohol	0.79	3960.0	1207	4.0	1.396	1.101
Ether	0.71	3231.6	985	4.9	0.3 11	0.222
Ethyl ether	0.71	3231.6	985	4.9	0.3 11	0.222
Ethylene glycol	1.11	5439.6	1658	2.1	17.208	19.153
Freon R12	—	2540	774.2	—	—	—
Gasoline	0.7	4098.4	1250	—	—	—
Glycerin	1.26	6246.7	1904	2.2	757.100	953.946
Glycol	1.11	5439.6	1658	2.1	—	—
Isobutanol	0.81	3976.4	1212	—	—	—
Iso-Butane	—	4002	1219.8	—	—	—
Isopentane	0.62	3215.2	980	4.8	0.340	0.211
Isopropanol	0.79	3838.6	1170	—	2.718	2.134
Isopropyl Alcohol	0.79	3838.6	1170	—	2.718	2.134
Kerosene	0.81	4343.8	1324	3.6	—	—

Fluid	Specific Gravity 20° C	Sound Speed		delta-v/° C m/s/° C	Kinematic Viscosity (cSt)	Absolute Viscosity (Cp)
		ft/s	m/s			
Linalool	—	4590.2	1400	—	—	—
Linseed Oil	0.925...0.939	5803.3	1770	—	—	—
Methanol	0.79	3530.2	1076	2.92	0.695	0.550
Methyl Alcohol	0.79	3530.2	1076	2.92	0.695	0.550
Methylene Chloride	1.33	3510.5	1070	3.94	0.310	0.411
Methylethyl Ketone	—	3967.2	1210	—	—	—
Motor Oil (SAE 20/30)	0.88...0.935	4875.4	1487	—	—	—
Octane	0.70	3845.1	1172	4.14	0.730	0.513
Oil, Castor	0.97	4845.8	1477	3.6	0.670	0.649
Oil, Diesel	0.80	4101	1250	—	—	—
Oil (Lubricating X200)	—	5019.9	1530	—	—	—
Oil (Olive)	0.91	4694.9	1431	2.75	100.000	91 .200
Oil (Peanut)	0.94	4783.5	1458	—	—	—
Paraffin Oil	—	4655.7	1420	—	—	—
Pentane	0.626	3346.5	1020	—	0.363	0.227
Petroleum	0.876	4229.5	1290	—	—	—
1-Propanol	0.78	4009.2	1222	—	—	—
Refrigerant 11	1.49	2717.5	828.3	3.56	—	—
Refrigerant 12	1.52	2539.7	774.1	4.24	—	—
Refrigerant 14	1.75	2871.5	875.24	6.61	—	—
Refrigerant 21	1.43	2923.2	891	3.97	—	—
Refrigerant 22	1.49	2932.7	893.9	4.79	—	—
Refrigerant 113	1.56	2571.2	783.7	3.44	—	—
Refrigerant 114	1.46	2182.7	665.3	3.73	—	—
Refrigerant 115	—	2153.5	656.4	4.42	—	—
Refrigerant C318	1.62	1883.2	574	3.88	—	—
Silicone (30 cp)	0.99	3248	990	—	30.000	29.790
Toluene	0.87	4357	1328	4.27	0.644	0.558
Transformer Oil	—	4557.4	1390	—	—	—
Trichlorethylene	—	3442.6	1050	—	—	—
1,1,1 -Trichloroethane	1.33	3231.6	985	—	0.902	1.200
Turpentine	0.88	4117.5	1255	—	1.400	1.232
Water, distilled	0.996	4914.7	1498	-2.4	1.000	0.996
Water, heavy	1	4593	1400	—	—	—
Water, sea	1.025	5023	1531	-2.4	1.000	1.025
Wood Alcohol	0.791	3530.2	1076	2.92	0.695	0.550
m-Xylene	0.868	4406.2	1343	—	0.749	0.650
o-Xylene	0.897	4368.4	1331.5	4.1	0.903	0.810
p-Xylene	—	4376.8	1334	—	0.662	—

Figure 126: Fluid properties

Control. Manage. Optimize.

Dynasonics is a registered trademark of Badger Meter, Inc. Other trademarks appearing in this document are the property of their respective entities. Due to continuous research, product improvements and enhancements, Badger Meter reserves the right to change product or system specifications without notice, except to the extent an outstanding contractual obligation exists. © 2015 Badger Meter, Inc. All rights reserved.

www.badgermeter.com

The Americas | Badger Meter | 4545 West Brown Deer Rd | PO Box 245036 | Milwaukee, WI 53224-9536 | 800-876-3837 | 414-355-0400
México | Badger Meter de las Americas, S.A. de C.V. | Pedro Luis Ogazón N°32 | Esq. Angelina N°24 | Colonia Guadalupe Inn | CP 01050 | México, DF | México | +52-55-5662-0882
Europe, Middle East and Africa | Badger Meter Europa GmbH | Nurtinger Str 76 | 72639 Neuffen | Germany | +49-7025-9208-0
Europe, Middle East Branch Office | Badger Meter Europe | PO Box 341442 | Dubai Silicon Oasis, Head Quarter Building, Wing C, Office #C209 | Dubai / UAE | +971-4-371 2503
Czech Republic | Badger Meter Czech Republic s.r.o. | Mařikova 2082/26 | 621 00 Brno, Czech Republic | +420-5-41420411
Slovakia | Badger Meter Slovakia s.r.o. | Racianska 109/B | 831 02 Bratislava, Slovakia | +421-2-44 63 83 01
Asia Pacific | Badger Meter | 80 Marine Parade Rd | 21-06 Parkway Parade | Singapore 449269 | +65-63464836
China | Badger Meter | 7-1202 | 99 Hangzhong Road | Minhang District | Shanghai | China 201101 | +86-21-5763 5412